

Lecture 2: Graph width notions, dynamical programming

An Introduction to Parameterized Complexity

<https://clegra.github.io/paracompl.html>

Clemens Grabmayer

Ph.D. Program Advanced Course

Gran Sasso Science Institute

L'Aquila, Italy

June 9, 2026

Course overview

Monday, June 8 11.00 – 13.00	Tuesday, June 9 11.00 – 13.00	Wednesday, June 10 11.00 – 13.00	Thursday, June 11 11.00 – 13.00	Friday, June 13
<i>Algorithmic Techniques</i>			<i>Formal-Method & Algorithmic Techniques</i>	
Introduction & basic FPT results	Notions of bounded graph width	Example: Good Edge Labelings	Algorithmic Meta-Theorems	
motivation for FPT kernelization, Crown Lemma, Sunflower Lemma	path-, tree-, clique width, FPT-results by dynamic programming, transferring FPT results betw. width	<i>Guest Lecture</i> Davi de Andrade Iacono	1st-order logic, monadic 2nd-order logic, FPT-results by Courcelle's Theorems for tree and clique-width	
				14.30 – 16.30
				FPT-Intractability Classes & Hierarchies
				motivation for FP-intractability results, FPT-reductions, class XP (slicewise polynomial), W- and A-Hierarchies, placing problems on these hierarchies

Overview

- ▶ comparing parameterizations

Overview

- ▶ comparing parameterizations
- ▶ dynamical programming on trees, example:
 - ▶ WEIGHTED-INDEPENDENT-SET (and VERTEX-COVER)
- ▶ path-width
 - ▶ example: fpt-algorithm for bounded path-width
- ▶ tree-width
 - ▶ example: fpt-algorithm for bounded path-width

Overview

- ▶ comparing parameterizations
- ▶ dynamical programming on trees, example:
 - ▶ WEIGHTED-INDEPENDENT-SET (and VERTEX-COVER)
- ▶ path-width
 - ▶ example: fpt-algorithm for bounded path-width
- ▶ tree-width
 - ▶ example: fpt-algorithm for bounded path-width
- ▶ fpt-results for other problems, obtained similarly

Overview

- ▶ comparing parameterizations
- ▶ dynamical programming on trees, example:
 - ▶ WEIGHTED-INDEPENDENT-SET (and VERTEX-COVER)
- ▶ path-width
 - ▶ example: fpt-algorithm for bounded path-width
- ▶ tree-width
 - ▶ example: fpt-algorithm for bounded path-width
- ▶ fpt-results for other problems, obtained similarly
- ▶ other notions of width
 - ▶ clique-width
 - ▶ using f -width to define:
 - ▶ carving-width (and cut-width)
 - ▶ branch-width
 - ▶ rank-width

Overview

- ▶ comparing parameterizations
- ▶ dynamical programming on trees, example:
 - ▶ WEIGHTED-INDEPENDENT-SET (and VERTEX-COVER)
- ▶ path-width
 - ▶ example: fpt-algorithm for bounded path-width
- ▶ tree-width
 - ▶ example: fpt-algorithm for bounded path-width
- ▶ fpt-results for other problems, obtained similarly
- ▶ other notions of width
 - ▶ clique-width
 - ▶ using f -width to define:
 - ▶ carving-width (and cut-width)
 - ▶ branch-width
 - ▶ rank-width
- ▶ comparing width-notions

Fixed-Parameter tractable

A *parameterized problem* is a triple $\langle Q, \Sigma, \kappa \rangle$ (short: $\langle Q, \kappa \rangle$) where:

- ▷ $Q \subseteq \Sigma^*$ is the set of (*classical*) *problem instances*,
- ▷ $\kappa : \Sigma^* \rightarrow \mathbb{N}$ is a (general) function, *the parameterization*.

Fixed-Parameter tractable

A *parameterized problem* is a triple $\langle Q, \Sigma, \kappa \rangle$ (short: $\langle Q, \kappa \rangle$) where:

- ▷ $Q \subseteq \Sigma^*$ is the set of (*classical*) *problem instances*,
- ▷ $\kappa : \Sigma^* \rightarrow \mathbb{N}$ is a (general) function, *the parameterization*.

Parameterized problem $\langle Q, \Sigma, \kappa \rangle$

Instance: $x \in \Sigma^*$.

Parameter: $\kappa(x)$.

Problem: Is $x \in Q$?

Fixed-Parameter tractable

A *parameterized problem* is a triple $\langle Q, \Sigma, \kappa \rangle$ (short: $\langle Q, \kappa \rangle$) where:

- ▷ $Q \subseteq \Sigma^*$ is the set of (*classical*) *problem instances*,
- ▷ $\kappa : \Sigma^* \rightarrow \mathbb{N}$ is a (general) function, *the parameterization*.

Definition

A parameterized problem $\langle Q, \Sigma, \kappa \rangle$ is *fixed-parameter tractable* (is in **FPT**) if:

$\exists f : \mathbb{N} \rightarrow \mathbb{N}$ computable $\exists p \in \mathbb{N}[X]$ polynomial

$\exists \mathbb{A}$ algorithm, takes inputs in Σ^*

$\forall x \in \Sigma^* [\mathbb{A} \text{ decides whether } x \in Q \text{ holds} \\ \text{in time } \leq f(\kappa(x)) \cdot p(|x|)]$

Fixed-Parameter tractable

A *parameterized problem* is a triple $\langle Q, \Sigma, \kappa \rangle$ (short: $\langle Q, \kappa \rangle$) where:

- ▷ $Q \subseteq \Sigma^*$ is the set of (*classical*) *problem instances*,
- ▷ $\kappa : \Sigma^* \rightarrow \mathbb{N}$ is a (general) function, *the parameterization*.

Definition

A parameterized problem $\langle Q, \Sigma, \kappa \rangle$ is *fixed-parameter tractable* (is in **FPT**) if:

$\exists f : \mathbb{N} \rightarrow \mathbb{N}$ computable $\exists p \in \mathbb{N}[X]$ polynomial

$\exists \mathbb{A}$ algorithm, takes inputs in Σ^*

$\forall x \in \Sigma^* [\mathbb{A} \text{ decides whether } x \in Q \text{ holds}$
 $\text{in time } \leq f(\kappa(x)) \cdot p(|x|)]$

†) Assumptions for a robust fpt-theory

$\kappa(x)$ is **polynomially computable**, or itself **fpt-computable**: for all $x \in \Sigma^*$ in time $\leq g(\kappa(x)) \cdot q(|x|)$ for g computable, $q \in \mathbb{N}[X]$.

Comparing parameterizations

Definition (computably bounded below)

Let $\kappa_1, \kappa_2 : \Sigma^* \rightarrow \mathbb{N}$ parameterizations.

- ▶ $\kappa_1 \succeq \kappa_2 : \iff \exists g : \mathbb{N} \rightarrow \mathbb{N}$ computable $\forall x \in \Sigma^* [g(\kappa_1(x)) \geq \kappa_2(x)]$.
- ▶ $\kappa_1 \approx \kappa_2 : \iff \kappa_1 \succeq \kappa_2 \wedge \kappa_2 \succeq \kappa_1$.
- ▶ $\kappa_1 \succ \kappa_2 : \iff \kappa_1 \succeq \kappa_2 \wedge \neg(\kappa_2 \succeq \kappa_1)$.

Comparing parameterizations

Definition (computably bounded below)

Let $\kappa_1, \kappa_2 : \Sigma^* \rightarrow \mathbb{N}$ parameterizations.

- ▶ $\kappa_1 \geq \kappa_2 : \iff \exists g : \mathbb{N} \rightarrow \mathbb{N}$ computable $\forall x \in \Sigma^* [g(\kappa_1(x)) \geq \kappa_2(x)]$.
- ▶ $\kappa_1 \approx \kappa_2 : \iff \kappa_1 \geq \kappa_2 \wedge \kappa_2 \geq \kappa_1$.
- ▶ $\kappa_1 > \kappa_2 : \iff \kappa_1 \geq \kappa_2 \wedge \neg(\kappa_2 \geq \kappa_1)$.

Proposition

For all parameterized problems $\langle Q, \kappa_1 \rangle$ and $\langle Q, \kappa_2 \rangle$ with parameterizations $\kappa_1, \kappa_2 : \Sigma^* \rightarrow \mathbb{N}$ with $\kappa_1 \geq \kappa_2$:

$$\langle Q, \kappa_1 \rangle \in \text{FPT} \iff \langle Q, \kappa_2 \rangle \in \text{FPT}$$

Comparing parameterizations

Definition (computably bounded below)

Let $\kappa_1, \kappa_2 : \Sigma^* \rightarrow \mathbb{N}$ parameterizations.

- ▶ $\kappa_1 \geq \kappa_2 : \iff \exists g : \mathbb{N} \rightarrow \mathbb{N}$ computable $\forall x \in \Sigma^* [g(\kappa_1(x)) \geq \kappa_2(x)]$.
- ▶ $\kappa_1 \approx \kappa_2 : \iff \kappa_1 \geq \kappa_2 \wedge \kappa_2 \geq \kappa_1$.
- ▶ $\kappa_1 > \kappa_2 : \iff \kappa_1 \geq \kappa_2 \wedge \neg(\kappa_2 \geq \kappa_1)$.

Proposition

For all parameterized problems $\langle Q, \kappa_1 \rangle$ and $\langle Q, \kappa_2 \rangle$ with parameterizations $\kappa_1, \kappa_2 : \Sigma^* \rightarrow \mathbb{N}$ with $\kappa_1 \geq \kappa_2$:

$$\langle Q, \kappa_1 \rangle \in \text{FPT} \iff \langle Q, \kappa_2 \rangle \in \text{FPT}$$

$$\langle Q, \kappa_1 \rangle \notin \text{FPT} \implies \langle Q, \kappa_2 \rangle \notin \text{FPT}$$

Computably boundedness between notions of width

(from Sasák, [5])

$$wd_1 \geq wd_2 : \Leftrightarrow wd_1 \xrightarrow{g} wd_2$$

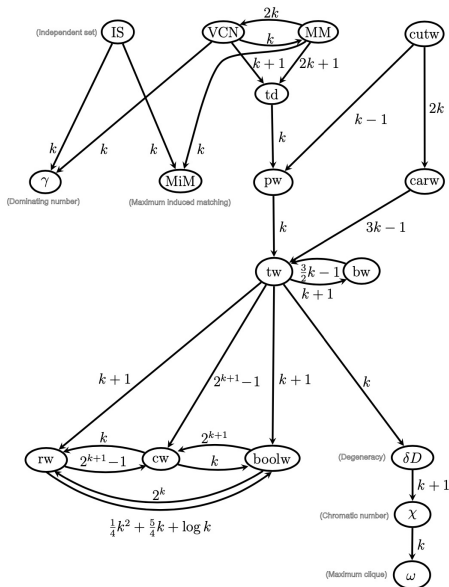

Computably boundedness between notions of width

(from Sasák, [5])

$$wd_1 \geq wd_2 : \Leftrightarrow wd_1 \xrightarrow{g} wd_2$$

► FPT-results

transfer upwards

(and conversely to \xrightarrow{g})

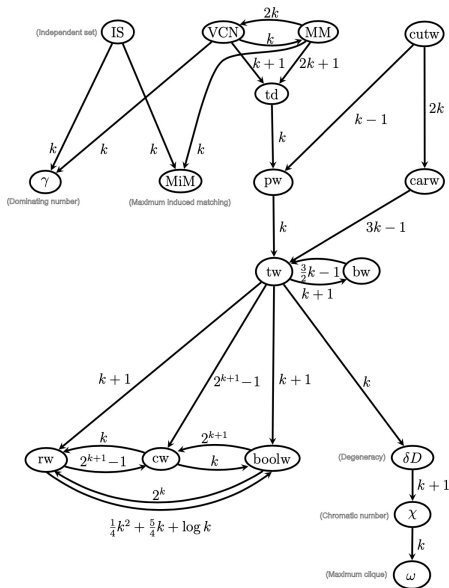

Computably boundedness between notions of width

(from Sasák, [5])

$$wd_1 \geq wd_2 : \Leftrightarrow wd_1 \xrightarrow{g} wd_2$$

► FPT-results

transfer upwards

(and conversely to \xrightarrow{g})

► (\notin FPT)-results

transfer downwards

(and along \xrightarrow{g})

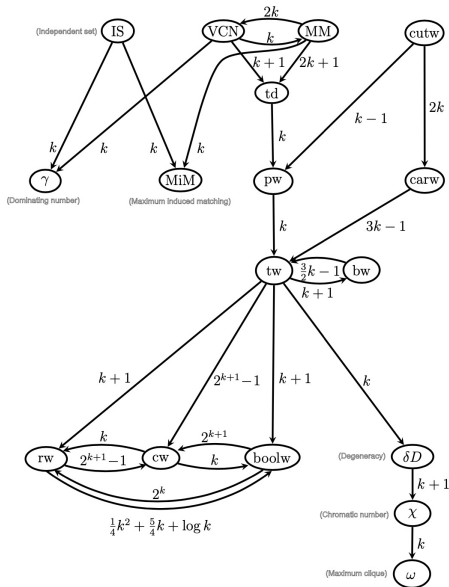

You Always Walk Alone (with your children)

Attività motoria con i figli:

'la possibilità di uscire con i figli minori è consentita a un solo genitore per camminare purché questo avvenga in prossimità della propria abitazione'

(Ministero dell'Interno)

You Always Walk Alone (with your children)

Attività motoria con i figli:

'la possibilità di uscire con i figli minori è consentita a un solo genitore per camminare purché questo avvenga in prossimità della propria abitazione'

(Ministero dell'Interno)

PHYSICAL-DISTANCE-WALKING

Instance: Graph $\mathcal{G} = \langle V, E \rangle$ with V people who want to go for a walk in the next hour in a radius of 200m of their home, and edges in E between them if they live closer than 400m of each other. A number $\ell \in \mathbb{N}$.

Problem:

You Always Walk Alone (with your children)

Attività motoria con i figli:

'la possibilità di uscire con i figli minori è consentita a un solo genitore per camminare purché questo avvenga in prossimità della propria abitazione'

(Ministero dell'Interno)

PHYSICAL-DISTANCE-WALKING

Instance: Graph $\mathcal{G} = \langle V, E \rangle$ with V people who want to go for a walk in the next hour in a radius of 200m of their home, and edges in E between them if they live closer than 400m of each other. A number $\ell \in \mathbb{N}$.

Problem: Is it possible that ℓ or more people can go out in the next hour so that everybody walks alone (with their children)?

You Always Walk Alone (with your children)

Attività motoria con i figli:

'la possibilità di uscire con i figli minori è consentita a un solo genitore per camminare purché questo avvenga in prossimità della propria abitazione'

(Ministero dell'Interno)

PHYSICAL-DISTANCE-WALKING

Instance: Graph $\mathcal{G} = \langle V, E \rangle$ with V people who want to go for a walk in the next hour in a radius of 200m of their home, and edges in E between them if they live closer than 400m of each other. A number $\ell \in \mathbb{N}$.

Problem: Is it possible that ℓ or more people can go out in the next hour so that everybody walks alone (with their children)?

corresponds to: INDEPENDENT-SET

Weighted Independent Set, and Vertex Cover

Let $\mathcal{G} = \langle V, E \rangle$ a graph. For all $S \subseteq V$:

S is **independent set** in \mathcal{G} : $\iff \forall e = \{u, v\} \in E (\neg(u \in S \wedge v \in S))$
 $\iff \forall e = \{u, v\} \in E (u \notin S \vee v \notin S)$

WEIGHTED-INDEPENDENT-SET

Instance: A graph $\mathcal{G} = \langle V, E \rangle$, and a **weight function** $w : V \rightarrow \mathbb{R}_0^+$.

Problem: What is the **max. weight of an independent set** of \mathcal{G} ?

Weighted Independent Set, and Vertex Cover

Let $\mathcal{G} = \langle V, E \rangle$ a graph. For all $S \subseteq V$:

S is **independent set** in $\mathcal{G} : \iff \forall e = \{u, v\} \in E (\neg(u \in S \wedge v \in S))$
 $\iff \forall e = \{u, v\} \in E (u \notin S \vee v \notin S)$

WEIGHTED-INDEPENDENT-SET

Instance: A graph $\mathcal{G} = \langle V, E \rangle$, and a **weight function** $w : V \rightarrow \mathbb{R}_0^+$.

Problem: What is the **max. weight of an independent set** of \mathcal{G} ?

S is a **vertex cover** of $\mathcal{G} : \iff \forall e = \{u, v\} \in E (u \in S \vee v \in S)$

Weighted Independent Set, and Vertex Cover

Let $\mathcal{G} = \langle V, E \rangle$ a graph. For all $S \subseteq V$:

S is **independent set** in $\mathcal{G} : \iff \forall e = \{u, v\} \in E (\neg(u \in S \wedge v \in S))$
 $\iff \forall e = \{u, v\} \in E (u \notin S \vee v \notin S)$

WEIGHTED-INDEPENDENT-SET

Instance: A graph $\mathcal{G} = \langle V, E \rangle$, and a **weight function** $w : V \rightarrow \mathbb{R}_0^+$.

Problem: What is the **max. weight of an independent set** of \mathcal{G} ?

S is a **vertex cover** of $\mathcal{G} : \iff \forall e = \{u, v\} \in E (u \in S \vee v \in S)$

VERTEX-COVER

Instance: A graph $\mathcal{G} = \langle V, E \rangle$, and $\ell \in \mathbb{N}$.

Problem: Does \mathcal{G} have a vertex cover of size at most ℓ ?

Weighted Independent Set, and Vertex Cover

Let $\mathcal{G} = \langle V, E \rangle$ a graph. For all $S \subseteq V$:

S is **independent set** in $\mathcal{G} : \iff \forall e = \{u, v\} \in E (\neg(u \in S \wedge v \in S))$
 $\iff \forall e = \{u, v\} \in E (u \notin S \vee v \notin S)$

WEIGHTED-INDEPENDENT-SET

Instance: A graph $\mathcal{G} = \langle V, E \rangle$, and a **weight function** $w : V \rightarrow \mathbb{R}_0^+$.

Problem: What is the **max. weight of an independent set** of \mathcal{G} ?

S is a **vertex cover** of $\mathcal{G} : \iff \forall e = \{u, v\} \in E (u \in S \vee v \in S)$
 $\iff \forall e = \{u, v\} \in E (u \notin V \setminus S \vee v \notin V \setminus S)$
 $\iff V \setminus S$ is an independent set of \mathcal{G}

VERTEX-COVER

Instance: A graph $\mathcal{G} = \langle V, E \rangle$, and $\ell \in \mathbb{N}$.

Problem: Does \mathcal{G} have a vertex cover of size at most ℓ ?

Weighted Independent Set, and Vertex Cover

Let $\mathcal{G} = \langle V, E \rangle$ a graph. For all $S \subseteq V$:

S is **independent set** in $\mathcal{G} : \iff \forall e = \{u, v\} \in E (\neg(u \in S \wedge v \in S))$
 $\iff \forall e = \{u, v\} \in E (u \notin S \vee v \notin S)$

WEIGHTED-INDEPENDENT-SET

Instance: A graph $\mathcal{G} = \langle V, E \rangle$, and a **weight function** $w : V \rightarrow \mathbb{R}_0^+$.

Problem: What is the **max. weight of an independent set** of \mathcal{G} ?

S is a **vertex cover** of $\mathcal{G} : \iff \forall e = \{u, v\} \in E (u \in S \vee v \in S)$
 $\iff \forall e = \{u, v\} \in E (u \notin V \setminus S \vee v \notin V \setminus S)$
 $\iff V \setminus S$ is an independent set of \mathcal{G}

VERTEX-COVER

Instance: A graph $\mathcal{G} = \langle V, E \rangle$, and $\ell \in \mathbb{N}$.

Problem: Does \mathcal{G} have a vertex cover of size at most ℓ ?

$S \subseteq V$ is **minimal** vertex cover $\iff V \setminus S$ is **maximal** independent set

Hence: solution of WEIGHTED-INDEPENDENT-SET

\implies solution of VERTEX-COVER.

Weighted Ind. Set / Vertex Cover, width-parameterized

p^* -WEIGHTED-INDEPENDENT-SET

Instance: A graph $\mathcal{G} = \langle V, E \rangle$, and a weight function $w : V \rightarrow \mathbb{R}_0^+$.

Parameter: path-width / tree-width k .

Problem: What is the max. weight of an independent set of \mathcal{G} ?

p^* -VERTEX-COVER

Instance: A graph $\mathcal{G} = \langle V, E \rangle$, and $\ell \in \mathbb{N}$.

Parameter: path-width / tree-width k .

Problem: Does \mathcal{G} have a vertex cover of size at most ℓ ?

Dynamical programming on trees (example)

WEIGHTED-INDEPENDENT-SET

Instance: A tree $\mathcal{T} = \langle T, F \rangle$, and a weight function $w : T \rightarrow \mathbb{R}_0^+$.

Problem: What is the max. weight of an independent set of \mathcal{T} ?

Dynamical programming on trees (example)

WEIGHTED-INDEPENDENT-SET

Instance: A tree $\mathcal{T} = \langle T, F \rangle$, and a weight function $w : T \rightarrow \mathbb{R}_0^+$.

Problem: What is the max. weight of an independent set of \mathcal{T} ?

Obtain a directed tree $\mathcal{T} = \langle T, F, r \rangle$ (pick a root r , orient edges away).

- ▶ $A[v] :=$ max. weight of an independent set in subtree \mathcal{T}_v at v ,

Dynamical programming on trees (example)

WEIGHTED-INDEPENDENT-SET

Instance: A tree $\mathcal{T} = \langle T, F \rangle$, and a weight function $w : T \rightarrow \mathbb{R}_0^+$.

Problem: What is the max. weight of an independent set of \mathcal{T} ?

Obtain a directed tree $\mathcal{T} = \langle T, F, r \rangle$ (pick a root r , orient edges away).

- ▶ $A[v] :=$ max. weight of an independent set in subtree \mathcal{T}_v at v ,
- ▶ $B[v] :=$ max. weight of an ind. set in \mathcal{T}_v that does not contain v .

Dynamical programming on trees (example)

WEIGHTED-INDEPENDENT-SET

Instance: A tree $\mathcal{T} = \langle T, F \rangle$, and a weight function $w : T \rightarrow \mathbb{R}_0^+$.

Problem: What is the max. weight of an independent set of \mathcal{T} ?

Obtain a directed tree $\mathcal{T} = \langle T, F, r \rangle$ (pick a root r , orient edges away).

- ▶ $A[v] :=$ max. weight of an independent set in subtree \mathcal{T}_v at v ,
- ▶ $B[v] :=$ max. weight of an ind. set in \mathcal{T}_v that does not contain v .

Computation of $A[v]$ and $B[v]$:

- ▶ in leaves: $B[v] = 0$,

Dynamical programming on trees (example)

WEIGHTED-INDEPENDENT-SET

Instance: A tree $\mathcal{T} = \langle T, F \rangle$, and a weight function $w : T \rightarrow \mathbb{R}_0^+$.

Problem: What is the max. weight of an independent set of \mathcal{T} ?

Obtain a directed tree $\mathcal{T} = \langle T, F, r \rangle$ (pick a root r , orient edges away).

- ▶ $A[v] :=$ max. weight of an independent set in subtree \mathcal{T}_v at v ,
- ▶ $B[v] :=$ max. weight of an ind. set in \mathcal{T}_v that does not contain v .

Computation of $A[v]$ and $B[v]$:

- ▶ in leafs: $B[v] = 0, \quad A[v] = w(v).$

Dynamical programming on trees (example)

WEIGHTED-INDEPENDENT-SET

Instance: A tree $\mathcal{T} = \langle T, F \rangle$, and a weight function $w : T \rightarrow \mathbb{R}_0^+$.

Problem: What is the max. weight of an independent set of \mathcal{T} ?

Obtain a directed tree $\mathcal{T} = \langle T, F, r \rangle$ (pick a root r , orient edges away).

- ▶ $A[v] :=$ max. weight of an independent set in subtree \mathcal{T}_v at v ,
- ▶ $B[v] :=$ max. weight of an ind. set in \mathcal{T}_v that does not contain v .

Computation of $A[v]$ and $B[v]$:

- ▶ in leafs: $B[v] = 0, \quad A[v] = w(v).$
- ▶ for inner vertices v with children v_1, \dots, v_q :

$$B[v] = \sum_{i=1}^q A[v_i],$$

Dynamical programming on trees (example)

WEIGHTED-INDEPENDENT-SET

Instance: A tree $\mathcal{T} = \langle T, F \rangle$, and a weight function $w : T \rightarrow \mathbb{R}_0^+$.

Problem: What is the max. weight of an independent set of \mathcal{T} ?

Obtain a directed tree $\mathcal{T} = \langle T, F, r \rangle$ (pick a root r , orient edges away).

- ▶ $A[v] :=$ max. weight of an independent set in subtree \mathcal{T}_v at v ,
- ▶ $B[v] :=$ max. weight of an ind. set in \mathcal{T}_v that does not contain v .

Computation of $A[v]$ and $B[v]$:

- ▶ in leaves: $B[v] = 0, \quad A[v] = w(v).$
- ▶ for inner vertices v with children v_1, \dots, v_q :

$$B[v] = \sum_{i=1}^q A[v_i], \quad A[v] = \max\left\{B[v], w(v) + \sum_{i=1}^q B[v_i]\right\}.$$

Dynamical programming on trees (example)

WEIGHTED-INDEPENDENT-SET

Instance: A tree $\mathcal{T} = \langle T, F \rangle$, and a weight function $w : T \rightarrow \mathbb{R}_0^+$.

Problem: What is the max. weight of an independent set of \mathcal{T} ?

Obtain a directed tree $\mathcal{T} = \langle T, F, r \rangle$ (pick a root r , orient edges away).

- ▶ $A[v] :=$ max. weight of an independent set in subtree \mathcal{T}_v at v ,
- ▶ $B[v] :=$ max. weight of an ind. set in \mathcal{T}_v that does not contain v .

Computation of $A[v]$ and $B[v]$:

- ▶ in leafs: $B[v] = 0, \quad A[v] = w(v).$
- ▶ for inner vertices v with children v_1, \dots, v_q :

$$B[v] = \sum_{i=1}^q A[v_i], \quad A[v] = \max\left\{B[v], w(v) + \sum_{i=1}^q B[v_i]\right\}.$$

Solution: value of $A[r]$, can be computed bottom-up in linear time.

Dynamical programming on trees (example)

WEIGHTED-INDEPENDENT-SET

Instance: A tree $\mathcal{T} = \langle T, F \rangle$, and a weight function $w : T \rightarrow \mathbb{R}_0^+$.

Problem: What is the max. weight of an independent set of \mathcal{T} ?

Theorem

On *trees* with n nodes,

WEIGHTED-INDEPENDENT-SET \in DTIME($O(n)$).

Dynamical programming on trees (example)

WEIGHTED-INDEPENDENT-SET

Instance: A tree $\mathcal{T} = \langle T, F \rangle$, and a weight function $w : T \rightarrow \mathbb{R}_0^+$.

Problem: What is the max. weight of an independent set of \mathcal{T} ?

Theorem

On trees with n nodes,

WEIGHTED-INDEPENDENT-SET \in DTIME($O(n)$).

VERTEX-COVER

Instance: A tree $\mathcal{T} = \langle T, F \rangle$, and $\ell \in \mathbb{N}$.

Problem: Does \mathcal{T} have a vertex cover of size at most ℓ ?

Corollary

On trees with n nodes,

VERTEX-COVER \in DTIME($O(n)$).

Path-decomposition (example)

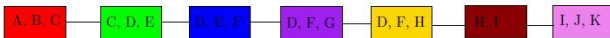
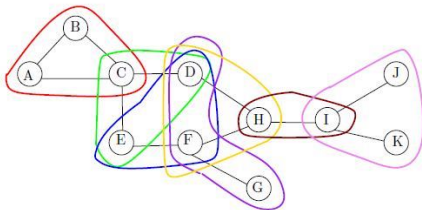
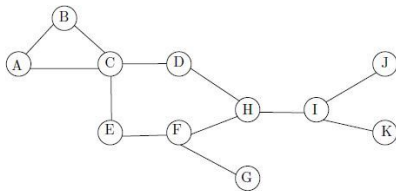

Path decompositions, and path-width

Definition (Robertson–Seymour, 1983)

A *path decomposition* of a graph $\mathcal{G} = \langle V, E \rangle$ is a sequence $\langle B_1, B_2, \dots, B_r \rangle$ of bags $B_i \subseteq V$ such that:

(P1) $V = \bigcup_{i=1}^r B_i$ (every vertex of \mathcal{G} is in some bag).

Path decompositions, and path-width

Definition (Robertson–Seymour, 1983)

A *path decomposition* of a graph $\mathcal{G} = \langle V, E \rangle$ is a sequence $\langle B_1, B_2, \dots, B_r \rangle$ of bags $B_i \subseteq V$ such that:

(P1) $V = \bigcup_{i=1}^r B_i$ (every vertex of \mathcal{G} is in some bag).

(P2) $(\forall \{u, v\} \in E) (\exists i \in \{1, 2, \dots, r\}) [\{u, v\} \subseteq B_i]$
(every edge of \mathcal{G} is realized in some bag).

Path decompositions, and path-width

Definition (Robertson–Seymour, 1983)

A *path decomposition* of a graph $\mathcal{G} = \langle V, E \rangle$ is a sequence $\langle B_1, B_2, \dots, B_r \rangle$ of bags $B_i \subseteq V$ such that:

(P1) $V = \bigcup_{i=1}^r B_i$ (every vertex of \mathcal{G} is in some bag).

(P2) $(\forall \{u, v\} \in E) (\exists i \in \{1, 2, \dots, r\}) [\{u, v\} \subseteq B_i]$
(every edge of \mathcal{G} is realized in some bag).

(P3) $(\forall v \in V) (\exists i, k \in \{1, \dots, r\}, i \leq k) [\{j \mid v \in B_j\} = [i, k]]$
(the list of bags that contains a vertex of \mathcal{G} is $\langle B_i, \dots, B_k \rangle$ for some interval $[i, k]$)

Path decompositions, and path-width

Definition (Robertson–Seymour, 1983)

A *path decomposition* of a graph $\mathcal{G} = \langle V, E \rangle$ is a sequence $\langle B_1, B_2, \dots, B_r \rangle$ of bags $B_i \subseteq V$ such that:

(P1) $V = \bigcup_{i=1}^r B_i$ (every vertex of \mathcal{G} is in some bag).

(P2) $(\forall \{u, v\} \in E) (\exists i \in \{1, 2, \dots, r\}) [\{u, v\} \subseteq B_i]$
(every edge of \mathcal{G} is realized in some bag).

(P3) $(\forall v \in V) (\exists i, k \in \{1, \dots, r\}, i \leq k) [\{j \mid v \in B_j\} = [i, k]]$
(the list of bags that contains a vertex of \mathcal{G} is $\langle B_i, \dots, B_k \rangle$ for some interval $[i, k]$)

The *width* of path decomp. $\langle B_1, B_2, \dots, B_r \rangle$ is $\max \{|B_t| - 1 \mid 1 \leq t \leq r\}$.

Path decompositions, and path-width

Definition (Robertson–Seymour, 1983)

A *path decomposition* of a graph $\mathcal{G} = \langle V, E \rangle$ is a sequence $\langle B_1, B_2, \dots, B_r \rangle$ of bags $B_i \subseteq V$ such that:

(P1) $V = \bigcup_{i=1}^r B_i$ (every vertex of \mathcal{G} is in some bag).

(P2) $(\forall \{u, v\} \in E) (\exists i \in \{1, 2, \dots, r\}) [\{u, v\} \subseteq B_i]$
(every edge of \mathcal{G} is realized in some bag).

(P3) $(\forall v \in V) (\exists i, k \in \{1, \dots, r\}, i \leq k) [\{j \mid v \in B_j\} = [i, k]]$
(the list of bags that contains a vertex of \mathcal{G} is $\langle B_i, \dots, B_k \rangle$ for some interval $[i, k]$)

The *width* of path decomp. $\langle B_1, B_2, \dots, B_r \rangle$ is $\max \{|B_t| - 1 \mid 1 \leq t \leq r\}$.

The *path-width* $\text{pw}(\mathcal{G})$ of a graph $\mathcal{G} = \langle V, E \rangle$ is defined by:

$\text{pw}(\mathcal{G}) :=$ minimal width of a path decomposition of \mathcal{G} .

Path-decomposition (example)

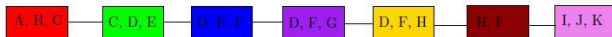
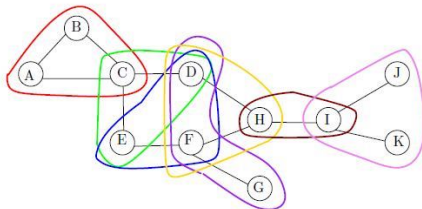
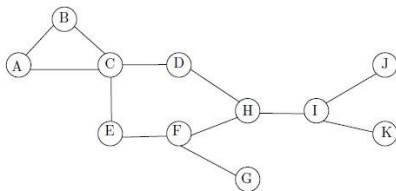

Path decomposition defines separations

Lemma

Let $\langle B_1, B_2, \dots, B_r \rangle$ be a path decomposition of a graph $\mathcal{G} = \langle V, E \rangle$.
Then for all $i \in \{1, \dots, r-1\}$ it holds:

- ▶ $\langle \bigcup_{j=1}^i B_j, \bigcup_{j=i+1}^r B_j \rangle$ is a separation of \mathcal{G} with separator $B_i \cap B_{i+1}$.

Path decomposition defines separations

Lemma

Let $\langle B_1, B_2, \dots, B_r \rangle$ be a path decomposition of a graph $\mathcal{G} = \langle V, E \rangle$.
 Then for all $i \in \{1, \dots, r-1\}$ it holds:

▶ $\langle \bigcup_{j=1}^i B_j, \bigcup_{j=i+1}^r B_j \rangle$ is a separation of \mathcal{G} with separator $B_i \cap B_{i+1}$.

▶ A pair $\langle A, B \rangle$ of subsets $A, B \subseteq V$ is a *separation* of \mathcal{G} if:

▶ $V = A \cup B$

▶ there is **no edge** between $A \setminus B$ and $B \setminus A$.

$A \cap B$ is called the *separator* of a separation $\langle A, B \rangle$,
 and $|A \cap B|$ is called its *order*.

Path decomposition defines separations

Lemma

Let $\langle B_1, B_2, \dots, B_r \rangle$ be a path decomposition of a graph $\mathcal{G} = \langle V, E \rangle$. Then for all $i \in \{1, \dots, r-1\}$ it holds:

- ▶ $\langle \bigcup_{j=1}^i B_j, \bigcup_{j=i+1}^r B_j \rangle$ is a separation of \mathcal{G} with separator $B_i \cap B_{i+1}$.
- ▶ $\partial(\bigcup_{j=1}^i B_j) \subseteq B_i \cap B_{i+1}$.

- ▶ A pair $\langle A, B \rangle$ of subsets $A, B \subseteq V$ is a *separation* of \mathcal{G} if:
 - ▶ $V = A \cup B$
 - ▶ there is **no edge** between $A \setminus B$ and $B \setminus A$.

$A \cap B$ is called the *separator* of a separation $\langle A, B \rangle$, and $|A \cap B|$ is called its *order*.

Path decomposition defines separations

Lemma

Let $\langle B_1, B_2, \dots, B_r \rangle$ be a path decomposition of a graph $\mathcal{G} = \langle V, E \rangle$. Then for all $i \in \{1, \dots, r-1\}$ it holds:

- ▶ $\langle \bigcup_{j=1}^i B_j, \bigcup_{j=i+1}^r B_j \rangle$ is a separation of \mathcal{G} with separator $B_i \cap B_{i+1}$.
- ▶ $\partial(\bigcup_{j=1}^i B_j) \subseteq B_i \cap B_{i+1}$.

- ▶ A pair $\langle A, B \rangle$ of subsets $A, B \subseteq V$ is a *separation* of \mathcal{G} if:

- ▶ $V = A \cup B$
- ▶ there is **no edge** between $A \setminus B$ and $B \setminus A$.

$A \cap B$ is called the *separator* of a separation $\langle A, B \rangle$, and $|A \cap B|$ is called its *order*.

- ▶ The *border (set of border vertices)* $\partial(A)$ of a set $A \subseteq V$ of vertices consists of all vertices that have a neighbor in $V \setminus A$.

Note that:

- ▶ $\langle A, (V \setminus A) \cup \partial(A) \rangle$ is a separation of \mathcal{G} , for all $A \subseteq V$.

Path-decomposition (example)

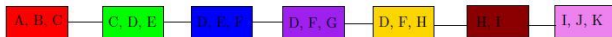
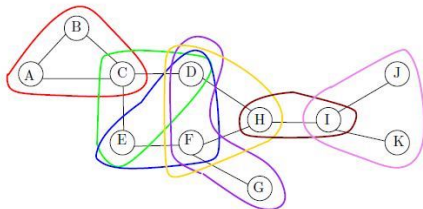
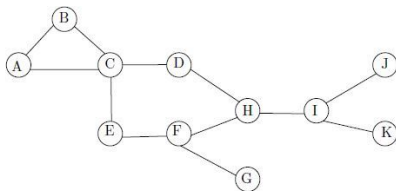

Caterpillar

Path-width?

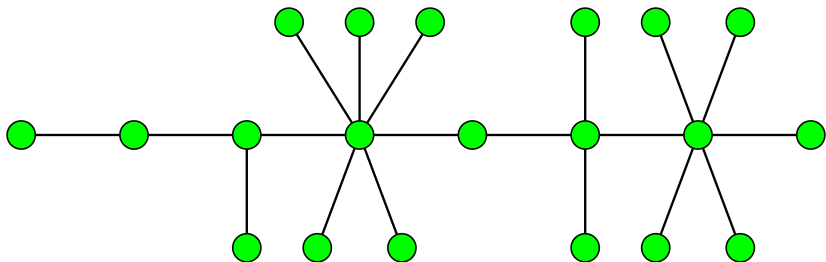

Nice path decomposition

Definition

A *path decomposition* $\langle B_1, B_2, \dots, B_r \rangle$ of a graph $\mathcal{G} = \langle V, E \rangle$ is *nice* if:

- ▶ $B_1 = B_r = \emptyset$
- ▶ Every index $i > 1$ is either of:
 - ▶ **introduce index**: there is $v \in V$ such that $B_{i+1} = B_i \cup \{v\}$ and $v \notin B_i$,
 - ▶ **forget index**: there is $v \in V$ such that $B_{i+1} = B_i \setminus \{v\}$ and $v \in B_i$.

Nice path decomposition

Definition

A *path decomposition* $\langle B_1, B_2, \dots, B_r \rangle$ of a graph $\mathcal{G} = \langle V, E \rangle$ is *nice* if:

- ▶ $B_1 = B_r = \emptyset$
- ▶ Every index $i > 1$ is either of:
 - ▶ **introduce index**: there is $v \in V$ such that $B_{i+1} = B_i \cup \{v\}$ and $v \notin B_i$,
 - ▶ **forget index**: there is $v \in V$ such that $B_{i+1} = B_i \setminus \{v\}$ and $v \in B_i$.

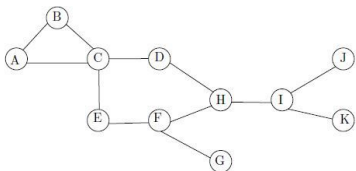

Nice path decomposition

Definition

A *path decomposition* $\langle B_1, B_2, \dots, B_r \rangle$ of a graph $\mathcal{G} = \langle V, E \rangle$ is *nice* if:

- ▶ $B_1 = B_r = \emptyset$
- ▶ Every index $i > 1$ is either of:
 - ▶ **introduce index**: there is $v \in V$ such that $B_{i+1} = B_i \cup \{v\}$ and $v \notin B_i$,
 - ▶ **forget index**: there is $v \in V$ such that $B_{i+1} = B_i \setminus \{v\}$ and $v \in B_i$.

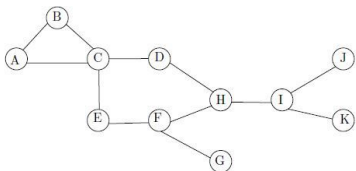

Nice path decomposition:

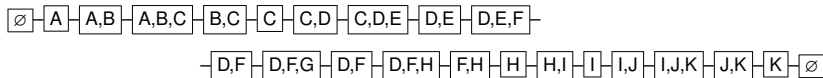

Nice path decomposition

Definition

A *path decomposition* $\langle B_1, B_2, \dots, B_r \rangle$ of a graph $\mathcal{G} = \langle V, E \rangle$ is *nice* if:

- ▶ $B_1 = B_r = \emptyset$
- ▶ Every index $i > 1$ is either of:
 - ▶ **introduce index**: there is $v \in V$ such that $B_{i+1} = B_i \cup \{v\}$ and $v \notin B_i$,
 - ▶ **forget index**: there is $v \in V$ such that $B_{i+1} = B_i \setminus \{v\}$ and $v \in B_i$.

Lemma

From every *path decomposition* $\langle B_1, B_2, \dots, B_r \rangle$ of a graph $\mathcal{G} = \langle V, E \rangle$ of width k a *nice path decomposition* $\langle B'_1, B'_2, \dots, B'_r \rangle$ of width k can be constructed in time $O(k^2 \cdot \max\{r, n\})$ where $n := |V|$.

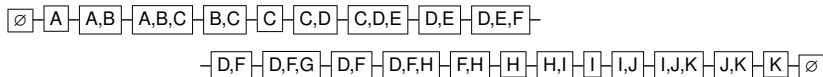

Weighted Independent Set

Let $\mathcal{G} = \langle V, E \rangle$ a graph.

$S \subseteq V$ is **independent set** in $\mathcal{G} : \iff \forall e = \{u, v\} (\neg(u \in S \wedge v \in S))$.

WEIGHTED-INDEPENDENT-SET

Instance: A graph $\mathcal{G} = \langle V, E \rangle$, and a **weight function** $w : V \rightarrow \mathbb{R}_0^+$.

Parameter: **path-width** k .

Problem: What is the **max. weight of an independent set** of \mathcal{G} ?

Path-decomposition (example)

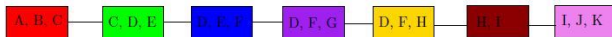
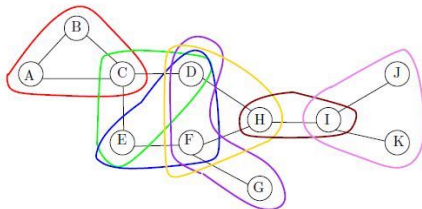
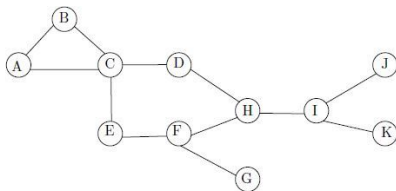

Dyn. programming using path-width (Weigh. Ind. Set)

Let $\langle B_1, \dots, B_r \rangle$ be a **nice path decomposition** of $\mathcal{G} = \langle V, E \rangle$.

Then for every $i \in \{1, \dots, r\}$, and every $S \subseteq B_i$, we define:

$$c[i, S] := \begin{cases} -\infty & \text{if } S \text{ is not independent} \\ \text{maximum possible weight of a set } \hat{S} \text{ such that} \\ \hat{S} \text{ is independent} \wedge S \subseteq \hat{S} \subseteq V_i = \bigcup_{j=1}^i B_j \wedge \hat{S} \cap B_i = S & \\ \text{if } S \text{ is independent.} & \end{cases}$$

Dyn. programming using path-width (Weigh. Ind. Set)

Let $\langle B_1, \dots, B_r \rangle$ be a **nice path decomposition** of $\mathcal{G} = \langle V, E \rangle$.

Then for every $i \in \{1, \dots, r\}$, and every $S \subseteq B_i$, we define:

$$c[i, S] := \begin{cases} -\infty & \text{if } S \text{ is not independent} \\ \text{maximum possible weight of a set } \hat{S} \text{ such that} \\ \hat{S} \text{ is independent} \wedge S \subseteq \hat{S} \subseteq V_i = \bigcup_{j=1}^i B_j \wedge \hat{S} \cap B_i = S & \\ \text{if } S \text{ is independent.} & \end{cases}$$

Recursive equations for computing $c[i, S]$ for **independent** S :

- ▶ Case $i = 1$: $c[1, \emptyset] = 0$

Dyn. programming using path-width (Weigh. Ind. Set)

Let $\langle B_1, \dots, B_r \rangle$ be a **nice path decomposition** of $\mathcal{G} = \langle V, E \rangle$.

Then for every $i \in \{1, \dots, r\}$, and every $S \subseteq B_i$, we define:

$$c[i, S] := \begin{cases} -\infty & \text{if } S \text{ is not independent} \\ \text{maximum possible weight of a set } \hat{S} \text{ such that} \\ \hat{S} \text{ is independent} \wedge S \subseteq \hat{S} \subseteq V_i = \bigcup_{j=1}^i B_j \wedge \hat{S} \cap B_i = S & \\ \text{if } S \text{ is independent.} & \end{cases}$$

Recursive equations for computing $c[i, S]$ for **independent** S :

▶ **Case** $i = 1$: $c[1, \emptyset] = 0$

▶ **Case** $i + 1$:

▶ $i + 1$ **introduces** v : $B_{i+1} = B_i \cup \{v\}$ and $v \notin B_i$,

$$c[i + 1, S] = \begin{cases} c[i, S] & \text{if } v \notin S, \end{cases}$$

Dyn. programming using path-width (Weigh. Ind. Set)

Let $\langle B_1, \dots, B_r \rangle$ be a **nice path decomposition** of $\mathcal{G} = \langle V, E \rangle$.

Then for every $i \in \{1, \dots, r\}$, and every $S \subseteq B_i$, we define:

$$c[i, S] := \begin{cases} -\infty & \text{if } S \text{ is not independent} \\ \text{maximum possible weight of a set } \hat{S} \text{ such that} \\ \hat{S} \text{ is independent} \wedge S \subseteq \hat{S} \subseteq V_i = \bigcup_{j=1}^i B_j \wedge \hat{S} \cap B_i = S & \\ \text{if } S \text{ is independent.} & \end{cases}$$

Recursive equations for computing $c[i, S]$ for **independent** S :

▶ **Case** $i = 1$: $c[1, \emptyset] = 0$

▶ **Case** $i + 1$:

▶ $i + 1$ **introduces** v : $B_{i+1} = B_i \cup \{v\}$ and $v \notin B_i$,

$$c[i + 1, S] = \begin{cases} c[i, S] & \text{if } v \notin S, \\ c[i, S \setminus \{v\}] + \mathbf{w}(v) & \text{if } v \in S; \end{cases}$$

Dyn. programming using path-width (Weigh. Ind. Set)

Let $\langle B_1, \dots, B_r \rangle$ be a **nice path decomposition** of $\mathcal{G} = \langle V, E \rangle$.

Then for every $i \in \{1, \dots, r\}$, and every $S \subseteq B_i$, we define:

$$c[i, S] := \begin{cases} -\infty & \text{if } S \text{ is not independent} \\ \text{maximum possible weight of a set } \hat{S} \text{ such that} \\ \hat{S} \text{ is independent} \wedge S \subseteq \hat{S} \subseteq V_i = \bigcup_{j=1}^i B_j \wedge \hat{S} \cap B_i = S & \\ \text{if } S \text{ is independent.} & \end{cases}$$

Recursive equations for computing $c[i, S]$ for **independent** S :

▶ **Case** $i = 1$: $c[1, \emptyset] = 0$

▶ **Case** $i + 1$:

▶ $i + 1$ **introduces** v : $B_{i+1} = B_i \cup \{v\}$ and $v \notin B_i$,

$$c[i+1, S] = \begin{cases} c[i, S] & \text{if } v \notin S, \\ c[i, S \setminus \{v\}] + \mathbf{w}(v) & \text{if } v \in S; \end{cases}$$

▶ $i + 1$ **forgets** v : $B_{i+1} = B_i \setminus \{v\}$ and $v \in B_i$,

$$c[i+1, S] = \max\{c[i, S], c[i, S \cup \{v\}]\}.$$

Dyn. programming using path-width (Weigh. Ind. Set)

Let $\langle B_1, \dots, B_r \rangle$ be a nice path dec. of $\mathcal{G} = \langle V, E \rangle$ of width k .

For every $i \in \{1, \dots, r\}$, and every independent $S \subseteq B_i$, we define:

$$c[i, S] := \begin{cases} \text{maximum possible weight of a set } \hat{S} \text{ such that} \\ \hat{S} \text{ is independent} \wedge S \subseteq \hat{S} \subseteq V_i = \bigcup_{j=1}^i B_j \wedge \hat{S} \cap B_i = S \end{cases}$$

Dyn. programming using path-width (Weigh. Ind. Set)

Let $\langle B_1, \dots, B_r \rangle$ be a nice path dec. of $\mathcal{G} = \langle V, E \rangle$ of width k .

For every $i \in \{1, \dots, r\}$, and every **independent** $S \subseteq B_i$, we define:

$$c[i, S] := \begin{cases} \text{maximum possible weight of a set } \hat{S} \text{ such that} \\ \hat{S} \text{ is independent} \wedge S \subseteq \hat{S} \subseteq V_i = \bigcup_{j=1}^i B_j \wedge \hat{S} \cap B_i = S \end{cases}$$

Time Complexity: Based on the values of $c[i, S]$, the **maximum possible weight of an independent set $S \subseteq V$** can be computed as:

Dyn. programming using path-width (Weigh. Ind. Set)

Let $\langle B_1, \dots, B_r \rangle$ be a nice path dec. of $\mathcal{G} = \langle V, E \rangle$ of width k .

For every $i \in \{1, \dots, r\}$, and every **independent** $S \subseteq B_i$, we define:

$$c[i, S] := \begin{cases} \text{maximum possible weight of a set } \hat{S} \text{ such that} \\ \hat{S} \text{ is independent} \wedge S \subseteq \hat{S} \subseteq V_i = \bigcup_{j=1}^i B_j \wedge \hat{S} \cap B_i = S \end{cases}$$

Time Complexity: Based on the values of $c[i, S]$, the **maximum possible weight of an independent set $S \subseteq V$** can be computed as:

$$= \max_{S \subseteq B_r} c[r, S] = c[r, \emptyset]$$

Dyn. programming using path-width (Weigh. Ind. Set)

Let $\langle B_1, \dots, B_r \rangle$ be a nice path dec. of $\mathcal{G} = \langle V, E \rangle$ of width k .

For every $i \in \{1, \dots, r\}$, and every **independent** $S \subseteq B_i$, we define:

$$c[i, S] := \begin{cases} \text{maximum possible weight of a set } \hat{S} \text{ such that} \\ \hat{S} \text{ is independent} \wedge S \subseteq \hat{S} \subseteq V_i = \bigcup_{j=1}^i B_j \wedge \hat{S} \cap B_i = S \end{cases}$$

Time Complexity: Based on the values of $c[i, S]$, the **maximum possible weight of an independent set $S \subseteq V$** can be computed as:

$$= \max_{S \subseteq B_r} c[r, S] = c[r, \emptyset]$$

Then for all $i \in \{1, \dots, n\}$:

▶ $|B_i| \leq k + 1$,

Dyn. programming using path-width (Weigh. Ind. Set)

Let $\langle B_1, \dots, B_r \rangle$ be a nice path dec. of $\mathcal{G} = \langle V, E \rangle$ of width k .

For every $i \in \{1, \dots, r\}$, and every **independent** $S \subseteq B_i$, we define:

$$c[i, S] := \begin{cases} \text{maximum possible weight of a set } \hat{S} \text{ such that} \\ \hat{S} \text{ is independent} \wedge S \subseteq \hat{S} \subseteq V_i = \bigcup_{j=1}^i B_j \wedge \hat{S} \cap B_i = S \end{cases}$$

Time Complexity: Based on the values of $c[i, S]$, the **maximum possible weight of an independent set $S \subseteq V$** can be computed as:

$$= \max_{S \subseteq B_r} c[r, S] = c[r, \emptyset]$$

Then for all $i \in \{1, \dots, n\}$:

- ▶ $|B_i| \leq k + 1$,
- ▶ \Rightarrow number of values $c[i, S]$ at index i : $2^{|B_i|} = 2^{k+1}$,

Dyn. programming using path-width (Weigh. Ind. Set)

Let $\langle B_1, \dots, B_r \rangle$ be a nice path dec. of $\mathcal{G} = \langle V, E \rangle$ of width k .

For every $i \in \{1, \dots, r\}$, and every **independent** $S \subseteq B_i$, we define:

$$c[i, S] := \begin{cases} \text{maximum possible weight of a set } \hat{S} \text{ such that} \\ \hat{S} \text{ is independent} \wedge S \subseteq \hat{S} \subseteq V_i = \bigcup_{j=1}^i B_j \wedge \hat{S} \cap B_i = S \end{cases}$$

Time Complexity: Based on the values of $c[i, S]$, the **maximum possible weight of an independent set $S \subseteq V$** can be computed as:

$$= \max_{S \subseteq B_r} c[r, S] = c[r, \emptyset]$$

Then for all $i \in \{1, \dots, n\}$:

- ▶ $|B_i| \leq k + 1$,
- ▶ \Rightarrow number of values $c[i, S]$ at index i : $2^{|B_i|} = 2^{k+1}$,
- ▶ \Rightarrow **adjacency/independence check** for $S \subseteq B_t$ possible in: $O(k^2)$
using a datastructure computable in time $O(k^{O(1)} \cdot n)$,

Dyn. programming using path-width (Weigh. Ind. Set)

Let $\langle B_1, \dots, B_r \rangle$ be a nice path dec. of $\mathcal{G} = \langle V, E \rangle$ of width k .

For every $i \in \{1, \dots, r\}$, and every **independent** $S \subseteq B_i$, we define:

$$c[i, S] := \begin{cases} \text{maximum possible weight of a set } \hat{S} \text{ such that} \\ \hat{S} \text{ is independent} \wedge S \subseteq \hat{S} \subseteq V_i = \bigcup_{j=1}^i B_j \wedge \hat{S} \cap B_i = S \end{cases}$$

Time Complexity: Based on the values of $c[i, S]$, the **maximum possible weight of an independent set $S \subseteq V$** can be computed as:

$$= \max_{S \subseteq B_r} c[r, S] = c[r, \emptyset]$$

Then for all $i \in \{1, \dots, n\}$:

- ▶ $|B_i| \leq k + 1$,
- ▶ \Rightarrow number of values $c[i, S]$ at index i : $2^{|B_i|} = 2^{k+1}$,
- ▶ \Rightarrow **adjacency/independence check** for $S \subseteq B_t$ possible in: $O(k^2)$
using a datastructure computable in time $O(k^{O(1)} \cdot n)$,
- ▶ time for comp. a value at i , using map of values at $i - 1$: $\sim O(k)$

Dyn. programming using path-width (Weigh. Ind. Set)

Let $\langle B_1, \dots, B_r \rangle$ be a nice path dec. of $\mathcal{G} = \langle V, E \rangle$ of width k .

For every $i \in \{1, \dots, r\}$, and every **independent** $S \subseteq B_i$, we define:

$$c[i, S] := \begin{cases} \text{maximum possible weight of a set } \hat{S} \text{ such that} \\ \hat{S} \text{ is independent} \wedge S \subseteq \hat{S} \subseteq V_i = \bigcup_{j=1}^i B_j \wedge \hat{S} \cap B_i = S \end{cases}$$

Time Complexity: Based on the values of $c[i, S]$, the **maximum possible weight of an independent set $S \subseteq V$** can be computed as:

$$= \max_{S \subseteq B_r} c[r, S] = c[r, \emptyset]$$

Then for all $i \in \{1, \dots, n\}$:

- ▶ $|B_i| \leq k + 1$,
- ▶ \Rightarrow number of values $c[i, S]$ at index i : $2^{|B_i|} = 2^{k+1}$,
- ▶ \Rightarrow **adjacency/independence check** for $S \subseteq B_t$ possible in: $O(k^2)$
using a datastructure computable in time $O(k^{O(1)} \cdot n)$,
- ▶ time for comp. a value at i , using map of values at $i - 1$: $\sim O(k)$
- ▶ time for comp. all values at i , using values at $i - 1$: $2^{k+1} \cdot O(k^2)$

Dyn. programming using path-width (Weigh. Ind. Set)

Let $\langle B_1, \dots, B_r \rangle$ be a nice path dec. of $\mathcal{G} = \langle V, E \rangle$ of width k .

For every $i \in \{1, \dots, r\}$, and every **independent** $S \subseteq B_i$, we define:

$$c[i, S] := \begin{cases} \text{maximum possible weight of a set } \hat{S} \text{ such that} \\ \hat{S} \text{ is independent} \wedge S \subseteq \hat{S} \subseteq V_i = \bigcup_{j=1}^i B_j \wedge \hat{S} \cap B_i = S \end{cases}$$

Time Complexity: Based on the values of $c[i, S]$, the **maximum possible weight of an independent set $S \subseteq V$** can be computed as:

$$= \max_{S \subseteq B_r} c[r, S] = c[r, \emptyset]$$

Then for all $i \in \{1, \dots, n\}$:

- ▶ $|B_i| \leq k + 1$,
- ▶ \Rightarrow number of values $c[i, S]$ at index i : $2^{|B_i|} = 2^{k+1}$,
- ▶ \Rightarrow **adjacency/independence check** for $S \subseteq B_t$ possible in: $O(k^2)$
using a datastructure computable in time $O(k^{O(1)} \cdot n)$,
- ▶ time for comp. a value at i , using map of values at $i - 1$: $\sim O(k)$
- ▶ time for comp. all values at i , using values at $i - 1$: $2^{k+1} \cdot O(k^2)$

\Rightarrow the time for computing all values at r :

$$(2^{k+1} \cdot O(k^2)) \cdot r + O(k^{O(1)} \cdot n) \in O(2^k \cdot k^{O(1)} \cdot n), \text{ since } r = 2n.$$

Dynamical programming with path width (example)

Theorem

For every graph $\mathcal{G} = \langle V, E \rangle$ with $|V| = n$ and *path-width* $\text{pw}(\mathcal{G}) = k$,
 p^* -WEIGHTED-INDEPENDENT-SET $\in \text{DTIME}(2^k \cdot k^{O(1)} \cdot n)$.

Dynamical programming with path width (example)

Theorem

For every graph $\mathcal{G} = \langle V, E \rangle$ with $|V| = n$ and *path-width* $\text{pw}(\mathcal{G}) = k$,
 p^* -WEIGHTED-INDEPENDENT-SET $\in \text{DTIME}(2^k \cdot k^{O(1)} \cdot n)$.

S is a *minimal* vertex cover

$\iff V \setminus S$ is a *maximal* independent set.

Dynamical programming with path width (example)

Theorem

For every graph $\mathcal{G} = \langle V, E \rangle$ with $|V| = n$ and *path-width* $\text{pw}(\mathcal{G}) = k$,
 p^* -WEIGHTED-INDEPENDENT-SET $\in \text{DTIME}(2^k \cdot k^{O(1)} \cdot n)$.

S is a *minimal* vertex cover

$\iff V \setminus S$ is a *maximal* independent set.

Corollary

For every graph $\mathcal{G} = \langle V, E \rangle$ with $|V| = n$ and *path-width* $\text{pw}(\mathcal{G}) = k$,
 p^* -VERTEX-COVER $\in \text{DTIME}(2^k \cdot k^{O(1)} \cdot n)$.

Tree decomposition (example)

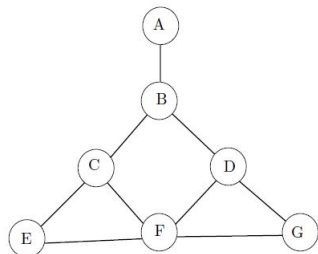

The original graph G

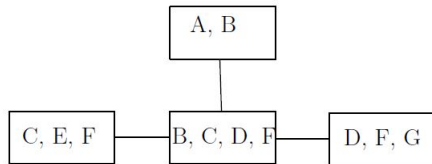

A tree-decomposition of width 3

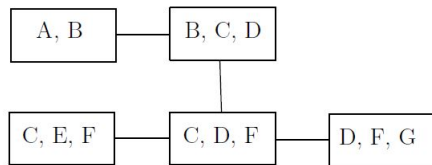

A tree-decomposition of width 2

Tree decompositions, and tree-width

Definition (Bertelé–Brioschi, 1972, Halin, 1976, Robertson–Seymour, 1984)

A *tree decomposition* of a graph $\mathcal{G} = \langle V, E \rangle$ is a pair $\langle \mathcal{T}, \{B_t\}_{t \in T} \rangle$ where $\mathcal{T} = \langle T, F \rangle$ a (undirected, unrooted) tree, and $B_t \subseteq V$ such that:

(T1) $V = \bigcup_{t \in T} B_t$ (every vertex of \mathcal{G} is in some bag).

Tree decompositions, and tree-width

Definition (Bertelé–Brioschi, 1972, Halin, 1976, Robertson–Seymour, 1984)

A *tree decomposition* of a graph $\mathcal{G} = \langle V, E \rangle$ is a pair $\langle \mathcal{T}, \{B_t\}_{t \in T} \rangle$ where $\mathcal{T} = \langle T, F \rangle$ a (undirected, unrooted) tree, and $B_t \subseteq V$ such that:

(T1) $V = \bigcup_{t \in T} B_t$ (every vertex of \mathcal{G} is in some bag).

(T2) $(\forall \{u, v\} \in E) (\exists t \in T) [\{u, v\} \subseteq B_t]$
 (the vertices of every edge of \mathcal{G} are realized in some bag).

Tree decompositions, and tree-width

Definition (Bertelé–Brioschi, 1972, Halin, 1976, Robertson–Seymour, 1984)

A *tree decomposition* of a graph $\mathcal{G} = \langle V, E \rangle$ is a pair $\langle \mathcal{T}, \{B_t\}_{t \in T} \rangle$ where $\mathcal{T} = \langle T, F \rangle$ a (undirected, unrooted) tree, and $B_t \subseteq V$ such that:

- (T1) $V = \bigcup_{t \in T} B_t$ (every vertex of \mathcal{G} is in some bag).
- (T2) $(\forall \{u, v\} \in E) (\exists t \in T) [\{u, v\} \subseteq B_t]$
(the vertices of every edge of \mathcal{G} are realized in some bag).
- (T3) $(\forall v \in V) [\text{subgraph of } \mathcal{T} \text{ defd. by } \{t \in T \mid v \in B_t\} \text{ is connected}]$
(the tree vertices (in \mathcal{T}) whose bags contain some vertex of \mathcal{G} induce a subgraph of \mathcal{T} that is connected).

Tree decompositions, and tree-width

Definition (Bertelé–Brioschi, 1972, Halin, 1976, Robertson–Seymour, 1984)

A *tree decomposition* of a graph $\mathcal{G} = \langle V, E \rangle$ is a pair $\langle \mathcal{T}, \{B_t\}_{t \in T} \rangle$ where $\mathcal{T} = \langle T, F \rangle$ a (undirected, unrooted) tree, and $B_t \subseteq V$ such that:

(T1) $V = \bigcup_{t \in T} B_t$ (every vertex of \mathcal{G} is in some bag).

(T2) $(\forall \{u, v\} \in E) (\exists t \in T) [\{u, v\} \subseteq B_t]$

(the vertices of every edge of \mathcal{G} are realized in some bag).

(T3) $(\forall v \in V) [\text{subgraph of } \mathcal{T} \text{ defd. by } \{t \in T \mid v \in B_t\} \text{ is connected}]$

(the tree vertices (in \mathcal{T}) whose bags contain some vertex of \mathcal{G} induce a subgraph of \mathcal{T} that is connected).

The *width* of a tree decomposition $\langle \mathcal{T}, \{B_t\}_{t \in T} \rangle$ is

$$\max \{|B_t| - 1 \mid t \in T\}.$$

Tree decompositions, and tree-width

Definition (Bertelé–Brioschi, 1972, Halin, 1976, Robertson–Seymour, 1984)

A *tree decomposition* of a graph $\mathcal{G} = \langle V, E \rangle$ is a pair $\langle \mathcal{T}, \{B_t\}_{t \in T} \rangle$ where $\mathcal{T} = \langle T, F \rangle$ a (undirected, unrooted) tree, and $B_t \subseteq V$ such that:

(T1) $V = \bigcup_{t \in T} B_t$ (every vertex of \mathcal{G} is in some bag).

(T2) $(\forall \{u, v\} \in E) (\exists t \in T) [\{u, v\} \subseteq B_t]$
(the vertices of every edge of \mathcal{G} are realized in some bag).

(T3) $(\forall v \in V) [\text{subgraph of } \mathcal{T} \text{ defd. by } \{t \in T \mid v \in B_t\} \text{ is connected}]$
(the tree vertices (in \mathcal{T}) whose bags contain some vertex of \mathcal{G} induce a subgraph of \mathcal{T} that is connected).

The *width* of a tree decomposition $\langle \mathcal{T}, \{B_t\}_{t \in T} \rangle$ is $\max \{|B_t| - 1 \mid t \in T\}$.

The *tree-width* $tw(\mathcal{G})$ of a graph $\mathcal{G} = \langle V, E \rangle$ is defined by:

$tw(\mathcal{G}) :=$ minimal width of a tree decomposition of \mathcal{G} .

Tree decomposition (example)

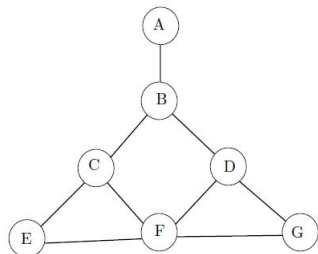

The original graph G

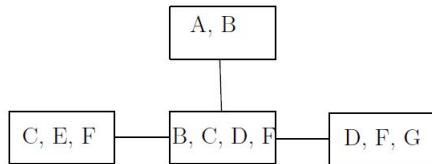

A tree-decomposition of width 3

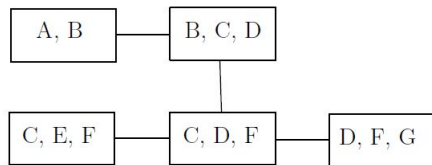

A tree-decomposition of width 2

Tree decomposition defines separations

Lemma

Let $\langle \mathcal{T}, \{B_t\}_{t \in \mathcal{T}} \rangle$ be a tree decomposition of a graph $\mathcal{G} = \langle V, E \rangle$.
 Let $e = \langle a, b \rangle$ be an edge of \mathcal{T} . The $\mathcal{T} \setminus e$ is the union of a tree \mathcal{T}_a containing a , and a tree \mathcal{T}_b containing b .

Then for $A := \bigcup_{t \in V(\mathcal{T}_a)} B_t$ and $B := \bigcup_{t \in V(\mathcal{T}_b)} B_t$ it holds:

- ▶ $\langle A, B \rangle$ is a separation of \mathcal{G} with separator $B_a \cap B_b$.

Recall, for a graph $\mathcal{G} = \langle V, E \rangle$:

Tree decomposition defines separations

Lemma

Let $\langle \mathcal{T}, \{B_t\}_{t \in \mathcal{T}} \rangle$ be a tree decomposition of a graph $\mathcal{G} = \langle V, E \rangle$. Let $e = \langle a, b \rangle$ be an edge of \mathcal{T} . The $\mathcal{T} \setminus e$ is the union of a tree \mathcal{T}_a containing a , and a tree \mathcal{T}_b containing b .

Then for $A := \bigcup_{t \in V(\mathcal{T}_a)} B_t$ and $B := \bigcup_{t \in V(\mathcal{T}_b)} B_t$ it holds:

- ▶ $\langle A, B \rangle$ is a separation of \mathcal{G} with separator $B_a \cap B_b$.

Recall, for a graph $\mathcal{G} = \langle V, E \rangle$:

- ▶ A pair $\langle A, B \rangle$ of subsets $A, B \subseteq V$ is a *separation* of \mathcal{G} if:
 - ▶ $V = A \cup B$
 - ▶ there is **no edge** between $A \setminus B$ and $B \setminus A$.

$A \cap B$ is called the *separator* of a separation $\langle A, B \rangle$, and $|A \cap B|$ is called its *order*.

Tree decomposition defines separations

Lemma

Let $\langle \mathcal{T}, \{B_t\}_{t \in \mathcal{T}} \rangle$ be a tree decomposition of a graph $\mathcal{G} = \langle V, E \rangle$. Let $e = \langle a, b \rangle$ be an edge of \mathcal{T} . The $\mathcal{T} \setminus e$ is the union of a tree \mathcal{T}_a containing a , and a tree \mathcal{T}_b containing b .

Then for $A := \bigcup_{t \in V(\mathcal{T}_a)} B_t$ and $B := \bigcup_{t \in V(\mathcal{T}_b)} B_t$ it holds:

- ▶ $\langle A, B \rangle$ is a separation of \mathcal{G} with separator $B_a \cap B_b$.
- ▶ $\partial(A), \partial(B) \subseteq B_a \cap B_b$.

Recall, for a graph $\mathcal{G} = \langle V, E \rangle$:

- ▶ A pair $\langle A, B \rangle$ of subsets $A, B \subseteq V$ is a *separation* of \mathcal{G} if:
 - ▶ $V = A \cup B$
 - ▶ there is **no edge** between $A \setminus B$ and $B \setminus A$.

$A \cap B$ is called the *separator* of a separation $\langle A, B \rangle$, and $|A \cap B|$ is called its *order*.

Tree decomposition defines separations

Lemma

Let $\langle \mathcal{T}, \{B_t\}_{t \in \mathcal{T}} \rangle$ be a tree decomposition of a graph $\mathcal{G} = \langle V, E \rangle$. Let $e = \langle a, b \rangle$ be an edge of \mathcal{T} . The $\mathcal{T} \setminus e$ is the union of a tree \mathcal{T}_a containing a , and a tree \mathcal{T}_b containing b .

Then for $A := \bigcup_{t \in V(\mathcal{T}_a)} B_t$ and $B := \bigcup_{t \in V(\mathcal{T}_b)} B_t$ it holds:

- ▶ $\langle A, B \rangle$ is a separation of \mathcal{G} with separator $B_a \cap B_b$.
- ▶ $\partial(A), \partial(B) \subseteq B_a \cap B_b$.

Recall, for a graph $\mathcal{G} = \langle V, E \rangle$:

- ▶ A pair $\langle A, B \rangle$ of subsets $A, B \subseteq V$ is a *separation* of \mathcal{G} if:
 - ▶ $V = A \cup B$
 - ▶ there is **no edge** between $A \setminus B$ and $B \setminus A$.

$A \cap B$ is called the *separator* of a separation $\langle A, B \rangle$, and $|A \cap B|$ is called its *order*.

- ▶ The *border (vertices)* $\partial(A)$ of a set $A \subseteq V$ of vertices consists of all vertices that have a neighbor in $V \setminus A$.

Computing tree-width

TREE-WIDTH

Instance: A graph \mathcal{G} and $k \in \mathbb{N}$.

Problem: Decide whether $tw(\mathcal{G}) = k$.

Computing tree-width

TREE-WIDTH

Instance: A graph \mathcal{G} and $k \in \mathbb{N}$.

Problem: Decide whether $tw(\mathcal{G}) = k$.

Theorem

TREE-WIDTH is NP-complete.

Computing tree-width

TREE-WIDTH

Instance: A graph \mathcal{G} and $k \in \mathbb{N}$.

Problem: Decide whether $tw(\mathcal{G}) = k$.

Theorem

TREE-WIDTH is NP-complete.

p -TREE-WIDTH

Instance: A graph $\mathcal{G} = \langle V, E \rangle$ and $k \in \mathbb{N}$.

Parameter: k .

Problem: Decide whether $tw(\mathcal{G}) = k$.

Computing tree-width

TREE-WIDTH

Instance: A graph \mathcal{G} and $k \in \mathbb{N}$.

Problem: Decide whether $tw(\mathcal{G}) = k$.

Theorem

TREE-WIDTH is NP-complete.

p -TREE-WIDTH

Instance: A graph $\mathcal{G} = \langle V, E \rangle$ and $k \in \mathbb{N}$.

Parameter: k .

Problem: Decide whether $tw(\mathcal{G}) = k$.

Theorem

p -TREE-WIDTH is fixed-parameter tractable,
in time $2^{p(k)} \cdot n$ where $n := |V|$.

Nice tree decomposition

Definition

A *tree decomposition* $\langle \mathcal{T}, \{B_t\}_{t \in T} \rangle$ of graph $\mathcal{G} = \langle V, E \rangle$ is *nice* if it is based on the choice of a leaf as *root* r and the parent–children relation away from r such that:

- ▶ $B_r = \emptyset$, and $B_\ell = \emptyset$ for every leaf $\ell \in T$.
- ▶ Every non-leaf node $t \in T$ is of one of three types:
 - ▶ **introduce node**: t has exactly one child t' such that $B_t = B_{t'} \cup \{v\}$; we say v is **introduced** at t .
 - ▶ **forget node**: t has exactly one child t' such that $B_t = B_{t'} \setminus \{w\}$ for some $w \in B_{t'}$; we say w is **forgotten** at t .
 - ▶ **join node**: a node t with two children t_1, t_2 such that $B_t = B_{t_1} = B_{t_2}$.

Nice tree decomposition

Definition

A *tree decomposition* $\langle \mathcal{T}, \{B_t\}_{t \in \mathcal{T}} \rangle$ of graph $\mathcal{G} = \langle V, E \rangle$ is *nice* if it is based on the choice of a leaf as *root* r and the parent–children relation away from r such that:

- ▶ $B_r = \emptyset$, and $B_\ell = \emptyset$ for every leaf $\ell \in \mathcal{T}$.
- ▶ Every non-leaf node $t \in \mathcal{T}$ is of one of three types:
 - ▶ **introduce node**: t has exactly one child t' such that $B_t = B_{t'} \cup \{v\}$; we say v is **introduced** at t .
 - ▶ **forget node**: t has exactly one child t' such that $B_t = B_{t'} \setminus \{w\}$ for some $w \in B_{t'}$; we say w is **forgotten** at t .
 - ▶ **join node**: a node t with two children t_1, t_2 such that $B_t = B_{t_1} = B_{t_2}$.

Lemma

From every *tree decomposition* $\langle \mathcal{T}, \{B_t\}_{t \in \mathcal{T}} \rangle$ of a graph $\mathcal{G} = \langle V, E \rangle$ of *width* k a *nice tree decomposition* $\langle \mathcal{T}', \{B'_t\}_{t \in \mathcal{T}'} \rangle$ of *width* k and with $r := |V(\mathcal{T})| \in O(kn)$ vertices can be constructed in time $O(k^2 \cdot \max\{r, n\})$ where $n := |V|$.

Tree decomposition (example)

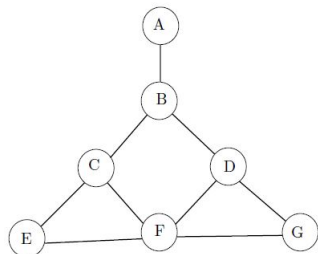

The original graph G

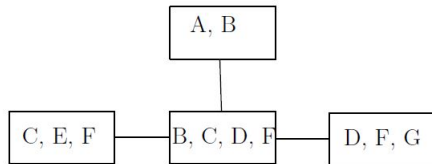

A tree-decomposition of width 3

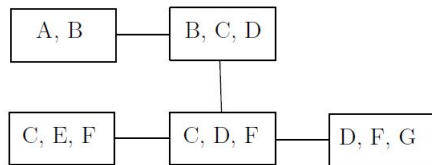

A tree-decomposition of width 2

Weighted Independent Set

Let $\mathcal{G} = \langle V, E \rangle$ a graph.

$S \subseteq V$ is **independent set** in $\mathcal{G} : \iff \forall e = \{u, v\} (\neg(u \in S \wedge v \in S))$.

WEIGHTED-INDEPENDENT-SET

Instance: A graph $\mathcal{G} = \langle V, E \rangle$, and a **weight function** $w : V \rightarrow \mathbb{R}_0^+$.

Parameter: **tree-width** k .

Problem: What is the **max. weight of an independent set** of \mathcal{G} ?

Dynamical programming using tree-width (example)

For every node t of a **nice tree decomposition**, and every $S \subseteq B_t$, we define:

$$c[t, S] := \begin{cases} -\infty & \text{if } S \text{ is not independent,} \\ \text{maximum possible weight of a set } \hat{S} \text{ such that} \\ \hat{S} \text{ is independent } \wedge S \subseteq \hat{S} \subseteq V_t \wedge \hat{S} \cap B_t = S & \\ \text{if } S \text{ is independent.} \end{cases}$$

Dynamical programming using tree-width (example)

For every node t of a **nice tree decomposition**, and every $S \subseteq B_t$, we define:

$$c[t, S] := \begin{cases} -\infty & \text{if } S \text{ is not independent,} \\ \text{maximum possible weight of a set } \hat{S} \text{ such that} \\ \hat{S} \text{ is independent } \wedge S \subseteq \hat{S} \subseteq V_t \wedge \hat{S} \cap B_t = S & \\ \text{if } S \text{ is independent.} \end{cases}$$

Recursive equations for computing $c[t, S]$ for **independent** S :

- ▶ leaf node t : $c[t, \emptyset] = 0$

Dynamical programming using tree-width (example)

For every node t of a **nice tree decomposition**, and every $S \subseteq B_t$, we define:

$$c[t, S] := \begin{cases} -\infty & \text{if } S \text{ is not independent,} \\ \text{maximum possible weight of a set } \hat{S} \text{ such that} \\ \hat{S} \text{ is independent } \wedge S \subseteq \hat{S} \subseteq V_t \wedge \hat{S} \cap B_t = S & \\ \text{if } S \text{ is independent.} \end{cases}$$

Recursive equations for computing $c[t, S]$ for **independent** S :

- ▶ leaf node t : $c[t, \emptyset] = 0$
- ▶ introduction node t of vertex v with child t' :

$$c[t, S] = \begin{cases} c[t', S] & \text{if } v \notin S \end{cases}$$

Dynamical programming using tree-width (example)

For every node t of a **nice tree decomposition**, and every $S \subseteq B_t$, we define:

$$c[t, S] := \begin{cases} -\infty & \text{if } S \text{ is not independent,} \\ \text{maximum possible weight of a set } \hat{S} \text{ such that} \\ \hat{S} \text{ is independent } \wedge S \subseteq \hat{S} \subseteq V_t \wedge \hat{S} \cap B_t = S & \\ \text{if } S \text{ is independent.} \end{cases}$$

Recursive equations for computing $c[t, S]$ for **independent** S :

- ▶ leaf node t : $c[t, \emptyset] = 0$
- ▶ introduction node t of vertex v with child t' :

$$c[t, S] = \begin{cases} c[t', S] & \text{if } v \notin S \\ c[t', S \setminus \{v\}] + w(v) & \text{otherwise} \end{cases}$$

Dynamical programming using tree-width (example)

For every node t of a **nice tree decomposition**, and every $S \subseteq B_t$, we define:

$$c[t, S] := \begin{cases} -\infty & \text{if } S \text{ is not independent,} \\ \text{maximum possible weight of a set } \hat{S} \text{ such that} \\ \hat{S} \text{ is independent } \wedge S \subseteq \hat{S} \subseteq V_t \wedge \hat{S} \cap B_t = S & \\ \text{if } S \text{ is independent.} \end{cases}$$

Recursive equations for computing $c[t, S]$ for **independent** S :

- ▶ leaf node t : $c[t, \emptyset] = 0$
- ▶ introduction node t of vertex v with child t' :

$$c[t, S] = \begin{cases} c[t', S] & \text{if } v \notin S \\ c[t', S \setminus \{v\}] + w(v) & \text{otherwise} \end{cases}$$

- ▶ forget node t of vertex v with child t' :

$$c[t, S] = \max\{c[t', S], c[t', S \cup \{v\}]\}$$

Dynamical programming using tree-width (example)

For every node t of a **nice tree decomposition**, and every $S \subseteq B_t$, we define:

$$c[t, S] := \begin{cases} -\infty & \text{if } S \text{ is not independent,} \\ \text{maximum possible weight of a set } \hat{S} \text{ such that} \\ \hat{S} \text{ is independent } \wedge S \subseteq \hat{S} \subseteq V_t \wedge \hat{S} \cap B_t = S & \\ \text{if } S \text{ is independent.} \end{cases}$$

Recursive equations for computing $c[t, S]$ for **independent** S :

- ▶ leaf node t : $c[t, \emptyset] = 0$
- ▶ introduction node t of vertex v with child t' :

$$c[t, S] = \begin{cases} c[t', S] & \text{if } v \notin S \\ c[t', S \setminus \{v\}] + w(v) & \text{otherwise} \end{cases}$$

- ▶ forget node t of vertex v with child t' :

$$c[t, S] = \max\{c[t', S], c[t', S \cup \{v\}]\}$$

- ▶ join node t with children t_1 and t_2 :

$$c[t, S] = c[t_1, S] + c[t_2, S] - w(S)$$

Dyn. programming using tree-width (Weigh. Ind. Set)

Let $\langle \mathcal{T} = \langle T, F, r \rangle, \{B_t\}_{t \in T} \rangle$ be a **nice tree decomposition** of $\mathcal{G} = \langle V, E \rangle$ of width k . For every $t \in T$, and every **independent** $S \subseteq B_t$:

$$c[t, S] := \begin{cases} \text{maximum possible weight of a set } \hat{S} \text{ such that} \\ \hat{S} \text{ is independent} \wedge S \subseteq \hat{S} \subseteq V_t = \bigcup_{s \in T_t} B_s \wedge \hat{S} \cap B_i = S \end{cases}$$

Dyn. programming using tree-width (Weigh. Ind. Set)

Let $\langle \mathcal{T} = \langle T, F, r \rangle, \{B_t\}_{t \in T} \rangle$ be a **nice tree decomposition** of $\mathcal{G} = \langle V, E \rangle$ of width k . For every $t \in T$, and every **independent** $S \subseteq B_t$:

$$c[t, S] := \begin{cases} \text{maximum possible weight of a set } \hat{S} \text{ such that} \\ \hat{S} \text{ is independent} \wedge S \subseteq \hat{S} \subseteq V_t = \bigcup_{s \in T_t} B_s \wedge \hat{S} \cap B_i = S \end{cases}$$

Time Complexity: Based on the values of $c[t, S]$, the **maximum possible weight of an independent set** $S \subseteq V$ can be computed as:

Dyn. programming using tree-width (Weigh. Ind. Set)

Let $\langle \mathcal{T} = \langle T, F, r \rangle, \{B_t\}_{t \in T} \rangle$ be a **nice tree decomposition** of $\mathcal{G} = \langle V, E \rangle$ of width k . For every $t \in T$, and every **independent** $S \subseteq B_t$:

$$c[t, S] := \begin{cases} \text{maximum possible weight of a set } \hat{S} \text{ such that} \\ \hat{S} \text{ is independent} \wedge S \subseteq \hat{S} \subseteq V_t = \bigcup_{s \in T_t} B_s \wedge \hat{S} \cap B_i = S \end{cases}$$

Time Complexity: Based on the values of $c[t, S]$, the **maximum possible weight of an independent set** $S \subseteq V$ can be computed as:

$$= \max_{S \subseteq B_r} c[r, S] = c[r, \emptyset]$$

Dyn. programming using tree-width (Weigh. Ind. Set)

Let $\langle \mathcal{T} = \langle T, F, r \rangle, \{B_t\}_{t \in T} \rangle$ be a **nice tree decomposition** of $\mathcal{G} = \langle V, E \rangle$ of width k . For every $t \in T$, and every **independent** $S \subseteq B_t$:

$$c[t, S] := \begin{cases} \text{maximum possible weight of a set } \hat{S} \text{ such that} \\ \hat{S} \text{ is independent} \wedge S \subseteq \hat{S} \subseteq V_t = \bigcup_{s \in T_t} B_s \wedge \hat{S} \cap B_i = S \end{cases}$$

Time Complexity: Based on the values of $c[t, S]$, the **maximum possible weight of an independent set** $S \subseteq V$ can be computed as:

$$= \max_{S \subseteq B_r} c[r, S] = c[r, \emptyset]$$

Then for all $t \in T$:

▶ $|B_t| \leq k + 1,$

Dyn. programming using tree-width (Weigh. Ind. Set)

Let $\langle \mathcal{T} = \langle T, F, r \rangle, \{B_t\}_{t \in T} \rangle$ be a **nice tree decomposition** of $\mathcal{G} = \langle V, E \rangle$ of width k . For every $t \in T$, and every **independent** $S \subseteq B_t$:

$$c[t, S] := \begin{cases} \text{maximum possible weight of a set } \hat{S} \text{ such that} \\ \hat{S} \text{ is independent} \wedge S \subseteq \hat{S} \subseteq V_t = \bigcup_{s \in T_t} B_s \wedge \hat{S} \cap B_i = S \end{cases}$$

Time Complexity: Based on the values of $c[t, S]$, the **maximum possible weight of an independent set** $S \subseteq V$ can be computed as:

$$= \max_{S \subseteq B_r} c[r, S] = c[r, \emptyset]$$

Then for all $t \in T$:

- ▶ $|B_t| \leq k + 1$,
- ▶ \Rightarrow number of values $c[t, S]$ at index t : $2^{|B_t|} = 2^{k+1}$,

Dyn. programming using tree-width (Weigh. Ind. Set)

Let $\langle \mathcal{T} = \langle T, F, r \rangle, \{B_t\}_{t \in T} \rangle$ be a **nice tree decomposition** of $\mathcal{G} = \langle V, E \rangle$ of width k . For every $t \in T$, and every **independent** $S \subseteq B_t$:

$$c[t, S] := \begin{cases} \text{maximum possible weight of a set } \hat{S} \text{ such that} \\ \hat{S} \text{ is independent} \wedge S \subseteq \hat{S} \subseteq V_t = \bigcup_{s \in T_t} B_s \wedge \hat{S} \cap B_i = S \end{cases}$$

Time Complexity: Based on the values of $c[t, S]$, the **maximum possible weight of an independent set** $S \subseteq V$ can be computed as:

$$= \max_{S \subseteq B_r} c[r, S] = c[r, \emptyset]$$

Then for all $t \in T$:

- ▶ $|B_t| \leq k + 1$,
- ▶ \Rightarrow number of values $c[t, S]$ at index t : $2^{|B_t|} = 2^{k+1}$,
- ▶ \Rightarrow **adjacency/independence check** for $S \subseteq B_t$ possible in: $O(k^2)$ using a datastructure computable in time $O(k^{O(1)} \cdot n)$,

Dyn. programming using tree-width (Weigh. Ind. Set)

Let $\langle \mathcal{T} = \langle T, F, r \rangle, \{B_t\}_{t \in T} \rangle$ be a **nice tree decomposition** of $\mathcal{G} = \langle V, E \rangle$ of width k . For every $t \in T$, and every **independent** $S \subseteq B_t$:

$$c[t, S] := \begin{cases} \text{maximum possible weight of a set } \hat{S} \text{ such that} \\ \hat{S} \text{ is independent} \wedge S \subseteq \hat{S} \subseteq V_t = \bigcup_{s \in T_t} B_s \wedge \hat{S} \cap B_i = S \end{cases}$$

Time Complexity: Based on the values of $c[t, S]$, the **maximum possible weight of an independent set $S \subseteq V$** can be computed as:

$$= \max_{S \subseteq B_r} c[r, S] = c[r, \emptyset]$$

Then for all $t \in T$:

- ▶ $|B_t| \leq k + 1$,
- ▶ \Rightarrow number of values $c[t, S]$ at index t : $2^{|B_t|} = 2^{k+1}$,
- ▶ \Rightarrow **adjacency/independence check** for $S \subseteq B_t$ possible in: $O(k^2)$ using a datastructure computable in time $O(k^{O(1)} \cdot n)$,
- ▶ time for comp. a value at t , using map of values at $t - 1$: $O(k)$

Dyn. programming using tree-width (Weigh. Ind. Set)

Let $\langle \mathcal{T} = \langle T, F, r \rangle, \{B_t\}_{t \in T} \rangle$ be a **nice tree decomposition** of $\mathcal{G} = \langle V, E \rangle$ of width k . For every $t \in T$, and every **independent** $S \subseteq B_t$:

$$c[t, S] := \begin{cases} \text{maximum possible weight of a set } \hat{S} \text{ such that} \\ \hat{S} \text{ is independent} \wedge S \subseteq \hat{S} \subseteq V_t = \bigcup_{s \in T_t} B_s \wedge \hat{S} \cap B_i = S \end{cases}$$

Time Complexity: Based on the values of $c[t, S]$, the **maximum possible weight of an independent set** $S \subseteq V$ can be computed as:

$$= \max_{S \subseteq B_r} c[r, S] = c[r, \emptyset]$$

Then for all $t \in T$:

- ▶ $|B_t| \leq k + 1$,
- ▶ \Rightarrow number of values $c[t, S]$ at index t : $2^{|B_t|} = 2^{k+1}$,
- ▶ \Rightarrow **adjacency/independence check** for $S \subseteq B_t$ possible in: $O(k^2)$ using a datastructure computable in time $O(k^{O(1)} \cdot n)$,
- ▶ time for comp. a value at t , using map of values at $t - 1$: $O(k)$
- ▶ time for comp. all values at t , using values at $t - 1$: $2^{k+1} \cdot O(k^2)$

Dyn. programming using tree-width (Weigh. Ind. Set)

Let $\langle \mathcal{T} = \langle T, F, r \rangle, \{B_t\}_{t \in T} \rangle$ be a **nice tree decomposition** of $\mathcal{G} = \langle V, E \rangle$ of width k . For every $t \in T$, and every **independent** $S \subseteq B_t$:

$$c[t, S] := \begin{cases} \text{maximum possible weight of a set } \hat{S} \text{ such that} \\ \hat{S} \text{ is independent} \wedge S \subseteq \hat{S} \subseteq V_t = \bigcup_{s \in T_t} B_s \wedge \hat{S} \cap B_i = S \end{cases}$$

Time Complexity: Based on the values of $c[t, S]$, the **maximum possible weight of an independent set** $S \subseteq V$ can be computed as:

$$= \max_{S \subseteq B_r} c[r, S] = c[r, \emptyset]$$

Then for all $t \in T$:

- ▶ $|B_t| \leq k + 1$,
- ▶ \Rightarrow number of values $c[t, S]$ at index t : $2^{|B_t|} = 2^{k+1}$,
- ▶ \Rightarrow **adjacency/independence check** for $S \subseteq B_t$ possible in: $O(k^2)$ using a datastructure computable in time $O(k^{O(1)} \cdot n)$,
- ▶ time for comp. a value at t , using map of values at $t-1$: $O(k)$
- ▶ time for comp. all values at t , using values at $t-1$: $2^{k+1} \cdot O(k^2)$

\Rightarrow the time for computing all values at the root r :

$$(2^{k+1} \cdot O(k^2)) \cdot |T| + O(k^{O(1)} \cdot n) \in O(2^k \cdot k^{O(1)} \cdot n), \text{ since } |T| \in O(k \cdot n).$$

Dynamical programming with tree width (example)

Theorem

For every graph $\mathcal{G} = \langle V, E \rangle$ with $|V| = n$ and *tree-width* $tw(\mathcal{G}) = k$,
 p^* -WEIGHTED-INDEPENDENT-SET \in DTIME($2^k \cdot k^{O(1)} \cdot n$).

Dynamical programming with tree width (example)

Theorem

For every graph $\mathcal{G} = \langle V, E \rangle$ with $|V| = n$ and *tree-width* $tw(\mathcal{G}) = k$,
 p^* -WEIGHTED-INDEPENDENT-SET \in DTIME($2^k \cdot k^{O(1)} \cdot n$).

S is a *minimal* vertex cover

$\iff V \setminus S$ is a *maximal* independent set.

Dynamical programming with tree width (example)

Theorem

For every graph $\mathcal{G} = \langle V, E \rangle$ with $|V| = n$ and *tree-width* $tw(\mathcal{G}) = k$,
 p^* -WEIGHTED-INDEPENDENT-SET \in DTIME($2^k \cdot k^{O(1)} \cdot n$).

S is a *minimal* vertex cover

$\iff V \setminus S$ is a *maximal* independent set.

Corollary

For every graph $\mathcal{G} = \langle V, E \rangle$ with $|V| = n$ and *tree-width* $tw(\mathcal{G}) = k$,
 p^* -VERTEX-COVER \in DTIME($2^k \cdot k^{O(1)} \cdot n$).

Dyn. programming with tree-width: general strategy

We consider problem P for graphs $\mathcal{G} = \langle V, E \rangle$ of size n and nice tree decompositions $\langle \mathcal{T} = \langle T, F, r \rangle, \{B_t\}_{t \in T} \rangle$ of tree width k .

Dyn. programming with tree-width: general strategy

We consider problem P for graphs $\mathcal{G} = \langle V, E \rangle$ of size n and **nice tree decompositions** $\langle \mathcal{T} = \langle T, F, r \rangle, \{B_t\}_{t \in T} \rangle$ of tree width k .

- ▶ **Formulate** a family of properties that can be restricted to subtrees of \mathcal{T} such that
 - ▶ a solution of P can be obtained from the properties at the root of \mathcal{T} .
- ▶ **Find** recursion equations for bottom-up evaluation on \mathcal{T} .

Dyn. programming with tree-width: general strategy

We consider problem P for graphs $\mathcal{G} = \langle V, E \rangle$ of size n and **nice tree decompositions** $\langle \mathcal{T} = \langle T, F, r \rangle, \{B_t\}_{t \in T} \rangle$ of tree width k .

- ▶ **Formulate** a family of properties that can be restricted to subtrees of \mathcal{T} such that
 - ▶ a solution of P can be obtained from the properties at the root of \mathcal{T} .
- ▶ **Find** recursion equations for bottom-up evaluation on \mathcal{T} .
- ▶ **Prove** correctness of these recursion equations by showing two inequalities for each type of node:
 - ▶ one relating an optimum solution for the node to some solutions for its children,
 - ▶ one relating optimum solutions for a node's children to a solution for the node.

Dyn. programming with tree-width: general strategy

We consider problem P for graphs $\mathcal{G} = \langle V, E \rangle$ of size n and **nice tree decompositions** $\langle \mathcal{T} = \langle T, F, r \rangle, \{B_t\}_{t \in T} \rangle$ of tree width k .

- ▶ **Formulate** a family of properties that can be restricted to subtrees of \mathcal{T} such that
 - ▶ a solution of P can be obtained from the properties at the root of \mathcal{T} .
- ▶ **Find** recursion equations for bottom-up evaluation on \mathcal{T} .
- ▶ **Prove** correctness of these recursion equations by showing two inequalities for each type of node:
 - ▶ one relating an optimum solution for the node to some solutions for its children,
 - ▶ one relating optimum solutions for a node's children to a solution for the node.
- ▶ **Obtain** an estimate of the time needed to compute the properties in a node t depending on n and k .

Dyn. programming with tree-width: general strategy

We consider problem P for graphs $\mathcal{G} = \langle V, E \rangle$ of size n and **nice tree decompositions** $\langle \mathcal{T} = \langle T, F, r \rangle, \{B_t\}_{t \in T} \rangle$ of tree width k .

- ▶ **Formulate** a family of properties that can be restricted to subtrees of \mathcal{T} such that
 - ▶ a solution of P can be obtained from the properties at the root of \mathcal{T} .
- ▶ **Find** recursion equations for bottom-up evaluation on \mathcal{T} .
- ▶ **Prove** correctness of these recursion equations by showing two inequalities for each type of node:
 - ▶ one relating an optimum solution for the node to some solutions for its children,
 - ▶ one relating optimum solutions for a node's children to a solution for the node.
- ▶ **Obtain** an estimate of the time needed to compute the properties in a node t depending on n and k .
- ▶ **Sum up** the time needed to compute the solution(s) at root r of \mathcal{T} .
- ▶ **Add** time needed to obtain the solution of P from properties at r .

Dynamical programming: similar results (I)

Theorem

For every graph $\mathcal{G} = \langle V, E \rangle$ with $|V| = n$ and $tw(\mathcal{G}) = k$,

- ▶ p^* -VERTEX-COVER, INDEPENDENT-SET $\in \text{DTIME}(2^k \cdot k^{O(1)} \cdot n)$,
- ▶ p^* -DOMINATING-SET $\in \text{DTIME}(4^k \cdot k^{O(1)} \cdot n)$,
- ▶ p^* -ODD CYCLE TRAVERSAL $\in \text{DTIME}(3^k \cdot k^{O(1)} \cdot n)$,
- ▶ p^* -MAXCUT $\in \text{DTIME}(2^k \cdot k^{O(1)} \cdot n)$,
- ▶ p^* - q -COLORABILITY $\in \text{DTIME}(q^k \cdot k^{O(1)} \cdot n)$.

Dynamical programming: similar results (II)

Theorem

For every graph $\mathcal{G} = \langle V, E \rangle$ with $|V| = n$ and $tw(\mathcal{G}) = k$, the following problems are in $\text{DTIME}(k^{O(k)} \cdot n)$:

- ▶ p^* -STEINER-TREE,
- ▶ p^* -FEEDBACK-VERTEX-SET,
- ▶ p^* -HAMILTONIAN-PATH and p^* -LONGEST-PATH,
- ▶ p^* -HAMILTONIAN-CYCLE and p^* -LONGEST-CYCLE,
- ▶ p^* -CHROMATIC-NUMBER,
- ▶ p^* -CYCLE-PACKING,
- ▶ p^* -CONNECTED-VERTEX-COVER,
- ▶ p^* -CONNECTED-FEEDBACK-VERTEX-SET.

Clique width (example)

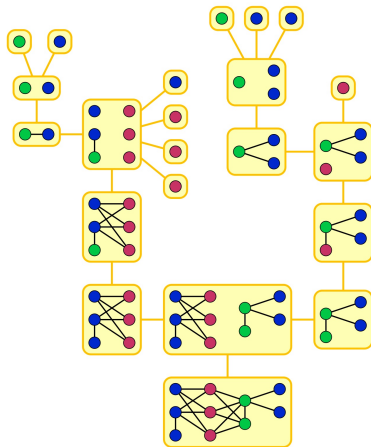

Clique-Width

For $k \in \mathbb{N}$, the k -expressions are defined by:

$$\varphi, \varphi_1, \varphi_2 ::= \mathbf{i} \mid \text{edge}_{i-j}(\varphi) \mid \text{recolor}_{i \rightarrow j}(\varphi) \mid (\varphi_1 \oplus \varphi_2)$$

for $i, j \in [k]$ with $i \neq j$.

Clique-Width

For $k \in \mathbb{N}$, the k -expressions are defined by:

$$\varphi, \varphi_1, \varphi_2 ::= \mathbf{i} \mid \text{edge}_{i-j}(\varphi) \mid \text{recolor}_{i \rightarrow j}(\varphi) \mid (\varphi_1 \oplus \varphi_2)$$

for $i, j \in [k]$ with $i \neq j$. k -expressions φ *generate* graphs $\mathcal{G}(\varphi)$:

Clique-Width

For $k \in \mathbb{N}$, the k -expressions are defined by:

$$\varphi, \varphi_1, \varphi_2 ::= i$$

for $i, j \in [k]$ with $i \neq j$. k -expressions φ generate graphs $\mathcal{G}(\varphi)$:

- ▷ $\mathcal{G}(i)$ is the graph with a single vertex of color i .

Clique-Width

For $k \in \mathbb{N}$, the k -expressions are defined by:

$$\varphi, \varphi_1, \varphi_2 ::= i \mid \text{edge}_{i-j}(\varphi)$$

for $i, j \in [k]$ with $i \neq j$. k -expressions φ *generate* graphs $\mathcal{G}(\varphi)$:

- ▷ $\mathcal{G}(i)$ is the graph with a single vertex of color i .
- ▷ $\mathcal{G}(\text{edge}_{i-j}(\varphi))$ results from $\mathcal{G}(\varphi)$ by adding edges between every vertex of color i and every vertex of color j .

Clique-Width

For $k \in \mathbb{N}$, the k -expressions are defined by:

$$\varphi, \varphi_1, \varphi_2 ::= i \mid \text{edge}_{i-j}(\varphi) \mid \text{recolor}_{i \rightarrow j}(\varphi)$$

for $i, j \in [k]$ with $i \neq j$. k -expressions φ *generate* graphs $\mathcal{G}(\varphi)$:

- ▷ $\mathcal{G}(i)$ is the graph with a single vertex of color i .
- ▷ $\mathcal{G}(\text{edge}_{i-j}(\varphi))$ results from $\mathcal{G}(\varphi)$ by adding edges between every vertex of color i and every vertex of color j .
- ▷ $\mathcal{G}(\text{recolor}_{i \rightarrow j}(\varphi))$ results from $\mathcal{G}(\varphi)$ by recoloring every vertex of color i by color j .

Clique-Width

For $k \in \mathbb{N}$, the k -expressions are defined by:

$$\varphi, \varphi_1, \varphi_2 ::= i \mid \text{edge}_{i-j}(\varphi) \mid \text{recolor}_{i \rightarrow j}(\varphi) \mid (\varphi_1 \oplus \varphi_2)$$

for $i, j \in [k]$ with $i \neq j$. k -expressions φ *generate* graphs $\mathcal{G}(\varphi)$:

- ▷ $\mathcal{G}(i)$ is the graph with a single vertex of color i .
- ▷ $\mathcal{G}(\text{edge}_{i-j}(\varphi))$ results from $\mathcal{G}(\varphi)$ by adding edges between every vertex of color i and every vertex of color j .
- ▷ $\mathcal{G}(\text{recolor}_{i \rightarrow j}(\varphi))$ results from $\mathcal{G}(\varphi)$ by recoloring every vertex of color i by color j .
- ▷ $\mathcal{G}(\varphi_1 \oplus \varphi_2)$ is the disjoint union of $\mathcal{G}(\varphi_1)$ and $\mathcal{G}(\varphi_2)$.

Clique-Width

For $k \in \mathbb{N}$, the k -expressions are defined by:

$$\varphi, \varphi_1, \varphi_2 ::= i \mid \text{edge}_{i-j}(\varphi) \mid \text{recolor}_{i \rightarrow j}(\varphi) \mid (\varphi_1 \oplus \varphi_2)$$

for $i, j \in [k]$ with $i \neq j$. k -expressions φ *generate* graphs $\mathcal{G}(\varphi)$:

- ▷ $\mathcal{G}(i)$ is the graph with a single vertex of color i .
- ▷ $\mathcal{G}(\text{edge}_{i-j}(\varphi))$ results from $\mathcal{G}(\varphi)$ by adding edges between every vertex of color i and every vertex of color j .
- ▷ $\mathcal{G}(\text{recolor}_{i \rightarrow j}(\varphi))$ results from $\mathcal{G}(\varphi)$ by recoloring every vertex of color i by color j .
- ▷ $\mathcal{G}(\varphi_1 \oplus \varphi_2)$ is the disjoint union of $\mathcal{G}(\varphi_1)$ and $\mathcal{G}(\varphi_2)$.

Definition (Courcelle, Engelfriet, Rozenberg, 1993, [2])

The *clique-width* $clw(\mathcal{G})$ of $\mathcal{G} = \langle V, E \rangle$ is defined by:

$$clw(\mathcal{G}) := \text{the least } k \in \mathbb{N} \text{ such that, for some } k\text{-expression } \varphi, \\ \mathcal{G} = \mathcal{G}(\varphi) \text{ (when removing colors)}$$

Clique width (example)

Building a graph \mathcal{G} of clique-width $c/w(\mathcal{G}) = 3$:

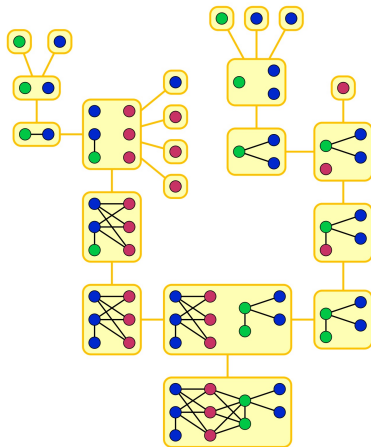

Clique-Width (examples, properties, computability)

Example

- ▶ The class of cliques has clique-width 2.

Clique-Width (examples, properties, computability)

Example

- ▶ The class of cliques has clique-width 2.
- ▶ The class of stars has clique-width 2.

Clique-Width (examples, properties, computability)

Example

- ▶ The class of cliques has clique-width 2.
- ▶ The class of stars has clique-width 2.
- ▶ The class of trees has clique-width 3.

Clique-Width (examples, properties, computability)

Example

- ▶ The class of cliques has clique-width 2.
- ▶ The class of stars has clique-width 2.
- ▶ The class of trees has clique-width 3.
- ▶ The class of $n \times n$ grids has clique-width $\Theta(n)$.

Clique-Width (examples, properties, computability)

Example

- ▶ The class of cliques has clique-width 2.
 - ▶ The class of stars has clique-width 2.
 - ▶ The class of trees has clique-width 3.
 - ▶ The class of $n \times n$ grids has clique-width $\Theta(n)$.
-
- ▶ subgraphs/induced subgraphs:
 - ▶ clique-width is preserved under taking induced subgraphs,
 - ▶ clique-width is **not preserved** under taking subgraphs (e.g. minors).

Clique-Width (examples, properties, computability)

Example

- ▶ The class of cliques has clique-width 2.
 - ▶ The class of stars has clique-width 2.
 - ▶ The class of trees has clique-width 3.
 - ▶ The class of $n \times n$ grids has clique-width $\Theta(n)$.
- ▶ subgraphs/induced subgraphs:
 - ▶ clique-width is preserved under taking induced subgraphs,
 - ▶ clique-width is **not preserved** under taking subgraphs (e.g. minors).
 - ▶ $clw < tw$:
 - ▶ $clw \leq tw$: $clw(\mathcal{G}) \leq 3 \cdot 2^{tw(\mathcal{G})-1}$
 - ▶ $\neg(tw \leq clw)$: for example, $clw(K_n) = 2$, and $tw(K_n) = n - 1$.

Clique-Width (examples, properties, computability)

Example

- ▶ The class of cliques has clique-width 2.
 - ▶ The class of stars has clique-width 2.
 - ▶ The class of trees has clique-width 3.
 - ▶ The class of $n \times n$ grids has clique-width $\Theta(n)$.
- ▶ subgraphs/induced subgraphs:
 - ▶ clique-width is preserved under taking induced subgraphs,
 - ▶ clique-width is **not preserved** under taking subgraphs (e.g. minors).
 - ▶ $c/w < tw$:
 - ▶ $c/w \leq tw$: $c/w(\mathcal{G}) \leq 3 \cdot 2^{tw(\mathcal{G})-1}$
 - ▶ $\neg(tw \leq c/w)$: for example, $c/w(K_n) = 2$, and $tw(K_n) = n - 1$.
 - ▶ Deciding whether $c/w(\mathcal{G}) \leq k$ is **NP-hard**. With parameter k it is in XP (slice-wise polynomial), but unknown to be in FPT.

Clique-Width (examples, properties, computability)

Example

- ▶ The class of cliques has clique-width 2.
 - ▶ The class of stars has clique-width 2.
 - ▶ The class of trees has clique-width 3.
 - ▶ The class of $n \times n$ grids has clique-width $\Theta(n)$.
- ▶ subgraphs/induced subgraphs:
 - ▶ clique-width is preserved under taking induced subgraphs,
 - ▶ clique-width is **not preserved** under taking subgraphs (e.g. minors).
 - ▶ $c/w < tw$:
 - ▶ $c/w \leq tw$: $c/w(\mathcal{G}) \leq 3 \cdot 2^{tw(\mathcal{G})-1}$
 - ▶ $\neg(tw \leq c/w)$: for example, $c/w(K_n) = 2$, and $tw(K_n) = n - 1$.
 - ▶ Deciding whether $c/w(\mathcal{G}) \leq k$ is **NP-hard**. With parameter k it is in XP (slice-wise polynomial), but unknown to be in FPT.
 - ▶ Every graph property expressible in **MSO (monadic second-order logic)** can be decided in linear time w.r.t. the graph's clique-width.

f -Width (of sets)

By a *cut function* or a *connectivity function* we mean a function $f : 2^U \rightarrow \mathbb{R}_0^+$ such that:

$$f \text{ is } \textit{symmetric} : \iff \forall X \subseteq U [f(X) = f(U \setminus X)];$$

f -Width (of sets)

By a *cut function* or a *connectivity function* we mean a function $f : 2^U \rightarrow \mathbb{R}_0^+$ such that:

f is *symmetric*: $\iff \forall X \subseteq U [f(X) = f(U \setminus X)]$;

f is *fair*: $\iff f(\emptyset) = f(U) = 0$.

f -Width (of sets)

By a *cut function* or a *connectivity function* we mean a function $f : 2^U \rightarrow \mathbb{R}_0^+$ such that:

f is *symmetric*: $\iff \forall X \subseteq U [f(X) = f(U \setminus X)]$;

f is *fair*: $\iff f(\emptyset) = f(U) = 0$.

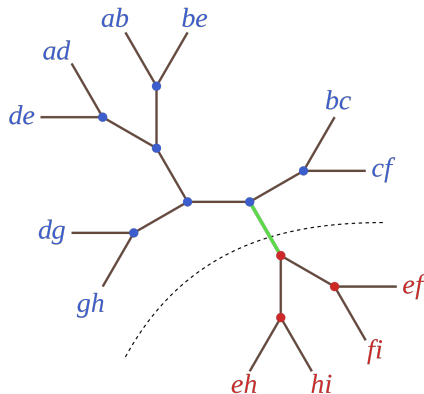

f -Width (of sets)

By a *cut function* or a *connectivity function* we mean a function $f : 2^U \rightarrow \mathbb{R}_0^+$ such that:

$$f \text{ is } \textit{symmetric} : \iff \forall X \subseteq U [f(X) = f(U \setminus X)];$$

$$f \text{ is } \textit{fair} : \iff f(\emptyset) = f(U) = 0.$$

Definition

Let U be a set, $f : 2^U \rightarrow \mathbb{R}_0^+$ a cut function.

A *branch decomposition* of U is a pair $\langle \mathcal{T}, \eta \rangle$ where:

- ▷ $\mathcal{T} = \langle T, F \rangle$ a tree.
- ▷ $\eta : U \rightarrow \text{Leafs}(\mathcal{T})$ a bijective function.

f -Width (of sets)

By a *cut function* or a *connectivity function* we mean a function $f : 2^U \rightarrow \mathbb{R}_0^+$ such that:

$$f \text{ is } \textit{symmetric} : \iff \forall X \subseteq U [f(X) = f(U \setminus X)];$$

$$f \text{ is } \textit{fair} : \iff f(\emptyset) = f(U) = 0.$$

Definition

Let U be a set, $f : 2^U \rightarrow \mathbb{R}_0^+$ a cut function.

A *branch decomposition* of U is a pair $\langle \mathcal{T}, \eta \rangle$ where:

- ▷ $\mathcal{T} = \langle T, F \rangle$ a tree.
- ▷ $\eta : U \rightarrow \text{Leafs}(\mathcal{T})$ a bijective function.

Every edge $e \in T$ splits the tree into two connected parts, and, via η , splits U into a partition $\langle X_e, Y_e \rangle$.

f -Width (of sets)

By a *cut function* or a *connectivity function* we mean a function $f : 2^U \rightarrow \mathbb{R}_0^+$ such that:

$$f \text{ is symmetric: } \iff \forall X \subseteq U [f(X) = f(U \setminus X)];$$

$$f \text{ is fair: } \iff f(\emptyset) = f(U) = 0.$$

Definition

Let U be a set, $f : 2^U \rightarrow \mathbb{R}_0^+$ a cut function.

A *branch decomposition* of U is a pair $\langle \mathcal{T}, \eta \rangle$ where:

- ▷ $\mathcal{T} = \langle T, F \rangle$ a tree.
- ▷ $\eta : U \rightarrow \text{Leafs}(\mathcal{T})$ a bijective function.

Every edge $e \in T$ splits the tree into two connected parts, and, via η , splits U into a partition $\langle X_e, Y_e \rangle$.

The *width* of an edge $e \in T$ (with respect to f) is $f(X_e) = f(Y_e)$. The *width of $\langle \mathcal{T}, \eta \rangle$ w.r.t. f* is the maximum width over the edges of \mathcal{T} .

f -Width (of sets)

By a *cut function* or a *connectivity function* we mean a function $f : 2^U \rightarrow \mathbb{R}_0^+$ such that:

$$f \text{ is } \textit{symmetric} : \iff \forall X \subseteq U [f(X) = f(U \setminus X)];$$

$$f \text{ is } \textit{fair} : \iff f(\emptyset) = f(U) = 0.$$

Definition

Let U be a set, $f : 2^U \rightarrow \mathbb{R}_0^+$ a cut function.

A *branch decomposition* of U is a pair $\langle \mathcal{T}, \eta \rangle$ where:

- ▷ $\mathcal{T} = \langle T, F \rangle$ a tree.
- ▷ $\eta : U \rightarrow \text{Leafs}(\mathcal{T})$ a bijective function.

Every edge $e \in T$ splits the tree into two connected parts, and, via η , splits U into a partition $\langle X_e, Y_e \rangle$.

The *width* of an edge $e \in T$ (with respect to f) is $f(X_e) = f(Y_e)$. The *width of $\langle \mathcal{T}, \eta \rangle$ w.r.t. f* is the maximum width over the edges of \mathcal{T} .

The *f -width $w_f(U)$* of U is defined as:

$$w_f(U) := \text{minimum width of branch decomp's of } U \text{ w.r.t. } f.$$

Branch-Width

Definition

Let $\mathcal{G} = \langle V, E \rangle$ be a graph. The *border (vertices)* of a set $X \subseteq E$ of edges is defined by:

$$\partial(X) := \left\{ v \in V \mid \exists e_1 \in X \exists e_2 \in E \setminus X \right. \\ \left. [v \text{ is incident to } e_1 \text{ and } e_2] \right\}$$

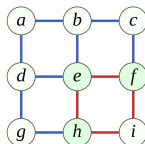

Branch-Width

Definition

Let $\mathcal{G} = \langle V, E \rangle$ be a graph. The *border (vertices)* of a set $X \subseteq E$ of edges is defined by:

$$\partial(X) := \left\{ v \in V \mid \exists e_1 \in X \exists e_2 \in E \setminus X \right. \\ \left. [v \text{ is incident to } e_1 \text{ and } e_2] \right\}$$

The *branch-width* $bw(\mathcal{G})$ of a graph $\mathcal{G} = \langle G, E \rangle$ is defined as

$$bw(\mathcal{G}) := w_f(E) \quad \text{for } f : 2^E \rightarrow \mathbb{R}_0^+, X \mapsto |\partial(X)|$$

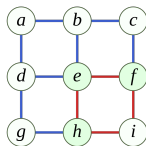

Branch-Width

Definition

Let $\mathcal{G} = \langle V, E \rangle$ be a graph. The *border (vertices)* of a set $X \subseteq E$ of edges is defined by:

$$\partial(X) := \left\{ v \in V \mid \exists e_1 \in X \exists e_2 \in E \setminus X \right. \\ \left. [v \text{ is incident to } e_1 \text{ and } e_2] \right\}$$

The *branch-width* $bw(\mathcal{G})$ of a graph $\mathcal{G} = \langle G, E \rangle$ is defined as

$$bw(\mathcal{G}) := w_f(E) \quad \text{for } f : 2^E \rightarrow \mathbb{R}_0^+, X \mapsto |\partial(X)|$$

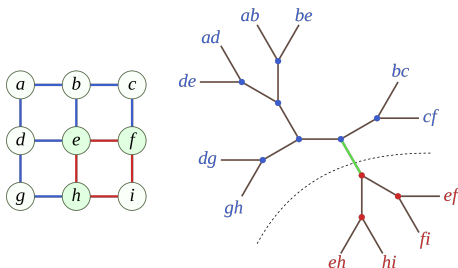

Branch-Width

Definition

Let $\mathcal{G} = \langle V, E \rangle$ be a graph. The *border (vertices)* of a set $X \subseteq E$ of edges is defined by:

$$\partial(X) := \left\{ v \in V \mid \exists e_1 \in X \exists e_2 \in E \setminus X \right. \\ \left. [v \text{ is incident to } e_1 \text{ and } e_2] \right\}$$

The *branch-width* $bw(\mathcal{G})$ of a graph $\mathcal{G} = \langle G, E \rangle$ is defined as

$$bw(\mathcal{G}) := w_f(E) \quad \text{for } f: 2^E \rightarrow \mathbb{R}_0^+, X \mapsto |\partial(X)|$$

Proposition

$bw(\mathcal{G}) \approx tw(\mathcal{G})$, for every graph; more precisely:

$$bw(\mathcal{G}) \leq tw(\mathcal{G}) + 1 \leq \frac{3}{2} \cdot bw(\mathcal{G}).$$

Rank-Width

Definition

Let $\mathcal{G} = \langle V, E \rangle$ be a graph.

For $X \subseteq V$ we define the $GF(2)$ -matrix:

$$B_{\mathcal{G}}(X) := (b_{x,y})_{x \in X, y \in V \setminus X}, \text{ where, for all } x \in X, y \in V \setminus X: \\ b_{x,y} = 1 \iff \{x, y\} \in E.$$

($B_{\mathcal{G}}(X)$ is the adjacency matrix of the bipartite graph induced by \mathcal{G} between X and $V \setminus X$.)

Rank-Width

Definition

Let $\mathcal{G} = \langle V, E \rangle$ be a graph.

For $X \subseteq V$ we define the $GF(2)$ -matrix:

$$B_{\mathcal{G}}(X) := (b_{x,y})_{x \in X, y \in V \setminus X}, \text{ where, for all } x \in X, y \in V \setminus X: \\ b_{x,y} = 1 \iff \{x, y\} \in E.$$

($B_{\mathcal{G}}(X)$ is the adjacency matrix of the bipartite graph induced by \mathcal{G} between X and $V \setminus X$.)

The *rank-width* $rw(\mathcal{G})$ of a graph $\mathcal{G} = \langle G, E \rangle$ is:

$$rw(\mathcal{G}) := w_{\rho_{\mathcal{G}}}(E) \quad \text{for } \rho_{\mathcal{G}} : 2^V \rightarrow \mathbb{N}_0, X \mapsto \text{rank of } B_{\mathcal{G}}(X)$$

Rank-Width

Definition

Let $\mathcal{G} = \langle V, E \rangle$ be a graph.

For $X \subseteq V$ we define the $GF(2)$ -matrix:

$$B_{\mathcal{G}}(X) := (b_{x,y})_{x \in X, y \in V \setminus X}, \text{ where, for all } x \in X, y \in V \setminus X:$$

$$b_{x,y} = 1 \iff \{x, y\} \in E.$$

($B_{\mathcal{G}}(X)$ is the adjacency matrix of the bipartite graph induced by \mathcal{G} between X and $V \setminus X$.)

The *rank-width* $rw(\mathcal{G})$ of a graph $\mathcal{G} = \langle G, E \rangle$ is:

$$rw(\mathcal{G}) := w_{\rho_{\mathcal{G}}}(E) \quad \text{for } \rho_{\mathcal{G}} : 2^V \rightarrow \mathbb{N}_0, X \mapsto \text{rank of } B_{\mathcal{G}}(X)$$

Properties

- ▶ $rw(\mathcal{G}) \leq tw(\mathcal{G})$.
- ▶ tree-width cannot be bounded functionally by rank-width:
 $rw(K_n) = 1$, but $tw(K_n) = n - 1$.

Carving-Width

Definition

Let $\mathcal{G} = \langle V, E \rangle$ be a graph.

For $X \subseteq V$ the *edge-cut* of X is:

$$\text{cut}_{\mathcal{G}}(X) := \{e = \{u, v\} \in E \mid u \in X, v \in V \setminus X\} .$$

The *carving-width* $\text{carw}(\mathcal{G})$ of a graph $\mathcal{G} = \langle G, E \rangle$ is:

$$\text{carw}(\mathcal{G}) := w_{\text{cut}}(E) \quad \text{for} \quad \text{cut} : 2^V \rightarrow \mathbb{N}_0, X \mapsto |\text{cut}_{\mathcal{G}}(X)| .$$

Carving-Width and Cut-Width

Definition

Let $\mathcal{G} = \langle V, E \rangle$ be a graph.

For $X \subseteq V$ the *edge-cut* of X is:

$$\text{cut}_{\mathcal{G}}(X) := \{e = \{u, v\} \in E \mid u \in X, v \in V \setminus X\} .$$

The *carving-width* $\text{carw}(\mathcal{G})$ of a graph $\mathcal{G} = \langle G, E \rangle$ is:

$$\text{carw}(\mathcal{G}) := w_{\text{cut}}(E) \quad \text{for} \quad \text{cut} : 2^V \rightarrow \mathbb{N}_0, X \mapsto |\text{cut}_{\mathcal{G}}(X)| .$$

Definition

Let $\mathcal{G} = \langle V, E \rangle$ be a graph with $n = |V|$.

For a permutation $\pi : \{1, \dots, n\} \rightarrow V$ on V we define:

$$\text{width}(\pi) := \max_{1 \leq i \leq n} \text{cut}_{\mathcal{G}}(\{\pi(j) \mid 1 \leq j \leq i\}) .$$

The *cut-width* $\text{cutw}(\mathcal{G})$ of \mathcal{G} is:

$$\text{cutw}(\mathcal{G}) := \min_{\pi \text{ perm. of } V} \text{width}(\pi) .$$

Coverage in Multi-Interface Networks



Coverage in Multi-Interface Networks



$CMI(p)$ (for $p \in \mathbb{N}$)

Instance: A graph $\mathcal{G} = \langle V, E \rangle$, $W : V \rightarrow 2^{\{1, \dots, a\}}$ available-interface allocation, $c : \{1, \dots, a\} \rightarrow \mathbb{R}^+$ interface cost function.

Coverage in Multi-Interface Networks



$CMI(p)$ (for $p \in \mathbb{N}$)

Instance: A graph $\mathcal{G} = \langle V, E \rangle$, $W : V \rightarrow 2^{\{1, \dots, a\}}$ available-interface allocation, $c : \{1, \dots, a\} \rightarrow \mathbb{R}^+$ interface cost function.

Solution: An allocation $W_A : V \rightarrow 2^{\{1, \dots, a\}}$ of active interfaces **covering** \mathcal{G} such that $W_A(v) \subseteq W(v)$, and $|W_A(v)| \leq p$ for all $v \in V$, if possible; otherwise, a negative answer.

Coverage in Multi-Interface Networks



$CMI(p)$ (for $p \in \mathbb{N}$)

Instance: A graph $\mathcal{G} = \langle V, E \rangle$, $W : V \rightarrow 2^{\{1, \dots, a\}}$ available-interface allocation, $c : \{1, \dots, a\} \rightarrow \mathbb{R}^+$ interface cost function.

Solution: An allocation $W_A : V \rightarrow 2^{\{1, \dots, a\}}$ of active interfaces **covering** \mathcal{G} such that $W_A(v) \subseteq W(v)$, and $|W_A(v)| \leq p$ for all $v \in V$, if possible; otherwise, a negative answer.

Problem: Obtain, if possible, a **minimal solution** with respect to the total cost of the interfaces that are activated, that is, $c(W_A) = \sum_{v \in V} \sum_{i \in W_A(v)} c(i)$.

Coverage in Multi-Interface Networks

Theorem

$CMI(2) \in \text{NP-complete}$, also for graphs with max. node degree ≥ 4 .

Coverage in Multi-Interface Networks (parameterized)

Theorem

$CMI(2) \in \text{NP-complete}$, also for graphs with max. node degree ≥ 4 .

p^* -CMI(p) (for $p \in \mathbb{N}$)

Instance: A graph $\mathcal{G} = \langle V, E \rangle$, $W : V \rightarrow 2^{\{1, \dots, a\}}$ available-interface allocation, $c : \{1, \dots, a\} \rightarrow \mathbb{R}^+$ interface cost function.

Parameter: path-width / carving-width k

Problem: Obtain, if possible, a minimal solution with respect to the total cost of the interfaces that are activated, that is,

$$c(W_A) = \sum_{v \in V} \sum_{i \in W_A(v)} c(i).$$

Coverage in Multi-Interface Networks (parameterized)

Theorem

$CMI(2) \in \text{NP-complete}$, also for graphs with max. node degree ≥ 4 .

p^* -CMI(p) (for $p \in \mathbb{N}$)

Instance: A graph $\mathcal{G} = \langle V, E \rangle$, $W : V \rightarrow 2^{\{1, \dots, a\}}$ available-interface allocation, $c : \{1, \dots, a\} \rightarrow \mathbb{R}^+$ interface cost function.

Parameter: path-width / carving-width k

Problem: Obtain, if possible, a minimal solution with respect to the total cost of the interfaces that are activated, that is,

$$c(W_A) = \sum_{v \in V} \sum_{i \in W_A(v)} c(i).$$

Theorem (Aloisio, Navarra, 2020, [1])

- ▶ For path-width $pw(\mathcal{G}) = k$,

$$p^*\text{-CMI}(2) \in \text{DTIME}(n \cdot (a + \binom{a}{2})^{k+1}).$$

Coverage in Multi-Interface Networks (parameterized)

Theorem

$CMI(2) \in \text{NP-complete}$, also for graphs with max. node degree ≥ 4 .

p^* -CMI(p) (for $p \in \mathbb{N}$)

Instance: A graph $\mathcal{G} = \langle V, E \rangle$, $W : V \rightarrow 2^{\{1, \dots, a\}}$ available-interface allocation, $c : \{1, \dots, a\} \rightarrow \mathbb{R}^+$ interface cost function.

Parameter: path-width / carving-width k

Problem: Obtain, if possible, a minimal solution with respect to the total cost of the interfaces that are activated, that is,

$$c(W_A) = \sum_{v \in V} \sum_{i \in W_A(v)} c(i).$$

Theorem (Aloisio, Navarra, 2020, [1])

- ▶ For path-width $pw(\mathcal{G}) = k$,

$$p^*\text{-CMI}(2) \in \text{DTIME}(n \cdot (a + \binom{a}{2})^{k+1}).$$
- ▶ For carving-width $carw(\mathcal{G}) = k$, $p^*\text{-CMI}(2) \in \text{DTIME}(n \cdot a^{4k}).$

Coverage in Multi-Interface Networks (parameterized)

Theorem (Aloisio, Navarra, 2020, [1])

- ▶ For *path-width* $pw(\mathcal{G}) = k$,
 p^* -CMI(2) \in DTIME($n \cdot (a + \binom{a}{2})^{k+1}$).
- ▶ For *carving-width* $carw(\mathcal{G}) = k$, p^* -CMI(2) \in DTIME($n \cdot a^{4k}$).

$(p^*)'$ -CMI(p) (for $p \in \mathbb{N}$)

Instance: A graph $\mathcal{G} = \langle V, E \rangle$, $W : V \rightarrow 2^{\{1, \dots, a\}}$ available-interface allocation, $c : \{1, \dots, a\} \rightarrow \mathbb{R}^+$ interface cost function.

Parameter: $a +$ (path-width / carving-width k)

Problem: Obtain, if possible, a minimal solution with respect to the total cost of the interfaces that are activated, that is,
 $c(W_A) = \sum_{v \in V} \sum_{i \in W_A(v)} c(i)$.

Coverage in Multi-Interface Networks (parameterized)

Theorem (Aloisio, Navarra, 2020, [1])

- ▶ For *path-width* $pw(\mathcal{G}) = k$,
 p^* -CMI(2) \in DTIME($n \cdot (a + \binom{a}{2})^{k+1}$).
- ▶ For *carving-width* $carw(\mathcal{G}) = k$, p^* -CMI(2) \in DTIME($n \cdot a^{4k}$).

$(p^*)'$ -CMI(p) (for $p \in \mathbb{N}$)

Instance: A graph $\mathcal{G} = \langle V, E \rangle$, $W : V \rightarrow 2^{\{1, \dots, a\}}$ available-interface allocation, $c : \{1, \dots, a\} \rightarrow \mathbb{R}^+$ interface cost function.

Parameter: $a +$ (path-width / carving-width k)

Problem: Obtain, if possible, a minimal solution with respect to the total cost of the interfaces that are activated, that is,
 $c(W_A) = \sum_{v \in V} \sum_{i \in W_A(v)} c(i)$.

Corollary

$(p^*)'$ -CMI(p) \in FPT.

Comparing parameterizations

Definition (computably bounded)

Let $\kappa_1, \kappa_2 : \Sigma^* \rightarrow \mathbb{N}$ parameterizations.

- ▶ $\kappa_1 \succeq \kappa_2 : \iff \exists g : \mathbb{N} \rightarrow \mathbb{N}$ computable $\forall x \in \Sigma^* [g(\kappa_1(x)) \geq \kappa_2(x)]$.
- ▶ $\kappa_1 \approx \kappa_2 : \iff \kappa_1 \succeq \kappa_2 \wedge \kappa_2 \succeq \kappa_1$.
- ▶ $\kappa_1 \succ \kappa_2 : \iff \kappa_1 \succeq \kappa_2 \wedge \neg(\kappa_2 \succeq \kappa_1)$.

Comparing parameterizations

Definition (computably bounded)

Let $\kappa_1, \kappa_2 : \Sigma^* \rightarrow \mathbb{N}$ parameterizations.

- ▶ $\kappa_1 \geq \kappa_2 : \iff \exists g : \mathbb{N} \rightarrow \mathbb{N}$ computable $\forall x \in \Sigma^* [g(\kappa_1(x)) \geq \kappa_2(x)]$.
- ▶ $\kappa_1 \approx \kappa_2 : \iff \kappa_1 \geq \kappa_2 \wedge \kappa_2 \geq \kappa_1$.
- ▶ $\kappa_1 > \kappa_2 : \iff \kappa_1 \geq \kappa_2 \wedge \neg(\kappa_2 \geq \kappa_1)$.

Proposition

For all parameterized problems $\langle Q, \kappa_1 \rangle$ and $\langle Q, \kappa_2 \rangle$ with parameterizations $\kappa_1, \kappa_2 : \Sigma^* \rightarrow \mathbb{N}$ with $\kappa_1 \geq \kappa_2$:

$$\langle Q, \kappa_1 \rangle \in \text{FPT} \iff \langle Q, \kappa_2 \rangle \in \text{FPT}$$

$$\langle Q, \kappa_1 \rangle \notin \text{FPT} \implies \langle Q, \kappa_2 \rangle \notin \text{FPT}$$

Computably boundedness between notions of width

(from Sasák, [5])

$$wd_1 \geq wd_2 : \Leftarrow wd_1 \xrightarrow{g(k)} wd_2$$

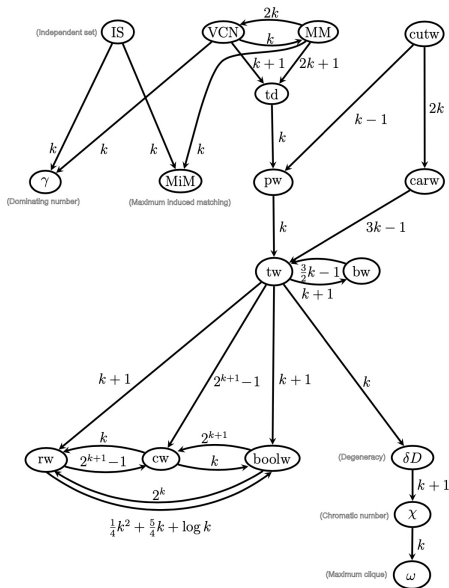

Computably boundedness between notions of width

(from Sasák, [5])

$$wd_1 \geq wd_2 : \Leftarrow wd_1 \xrightarrow{g(k)} wd_2$$

- ▶ FPT-results transfer upwards (and conversely to \xrightarrow{g})

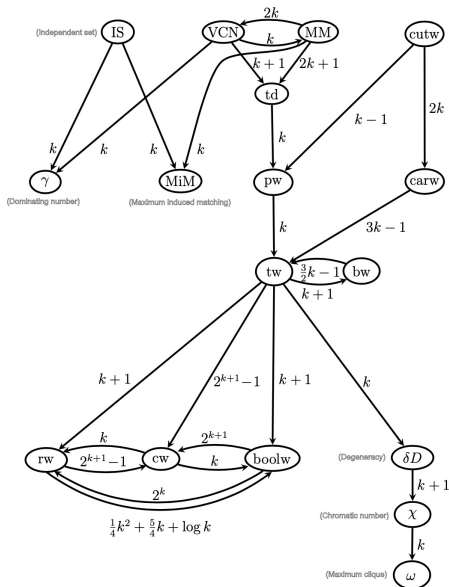

Computably boundedness between notions of width

(from Sasák, [5])

$$wd_1 \geq wd_2 : \Leftarrow wd_1 \xrightarrow{g(k)} wd_2$$

- ▶ FPT-results
transfer upwards
(and conversely to \xrightarrow{g})
- ▶ (\notin FPT)-results
transfer downwards
(and along \xrightarrow{g})

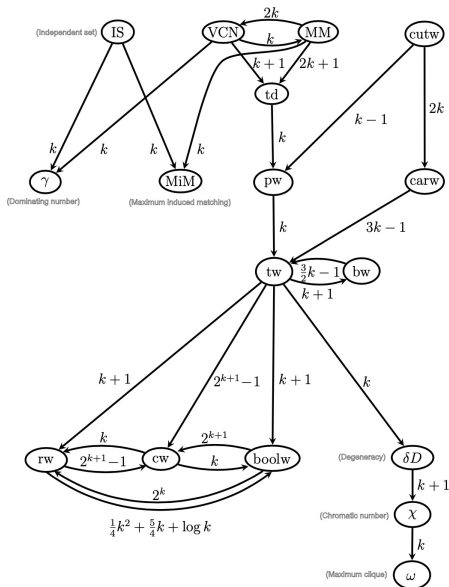

Summary

- ▶ comparing parameterizations
- ▶ dynamical programming on trees, example:
 - ▶ WEIGHTED-INDEPENDENT-SET (and VERTEX-COVER)
- ▶ path-width
 - ▶ example: fpt-algorithm for bounded path-width
- ▶ tree-width
 - ▶ example: fpt-algorithm for bounded path-width
- ▶ fpt-results for other problems, obtained similarly
- ▶ other notions of width
 - ▶ clique-width
 - ▶ using f -width to define:
 - ▶ carving-width (and cut-width)
 - ▶ branch-width
 - ▶ rank-width
- ▶ example problem: coverage in multi-interface networks
- ▶ comparing width-notions

Course overview

Monday, June 8 11.00 – 13.00	Tuesday, June 9 11.00 – 13.00	Wednesday, June 10 11.00 – 13.00	Thursday, June 11 11.00 – 13.00	Friday, June 13
<i>Algorithmic Techniques</i>			<i>Formal-Method & Algorithmic Techniques</i>	
Introduction & basic FPT results	Notions of bounded graph width	Example: Good Edge Labelings	Algorithmic Meta-Theorems	
motivation for FPT kernelization, Crown Lemma, Sunflower Lemma	path-, tree-, clique width, FPT-results by dynamic programming, transferring FPT results betw. width	<i>Guest Lecture</i> Davi de Andrade Iacono	1st-order logic, monadic 2nd-order logic, FPT-results by Courcelle's Theorems for tree and clique-width	
				14.30 – 16.30
				FPT-Intractability Classes & Hierarchies
				motivation for FP-intractability results, FPT-reductions, class XP (slicewise polynomial), W- and A-Hierarchies, placing problems on these hierarchies

Thursday

- ▶ recalling notions from logic:
 - ▶ propositional, and first-order logic
 - ▶ monadic second-order logic (MSO)
- ▶ **Courcelle's Theorem**: obtaining FPT-results by
 - ▶ model-checking of MSO-properties
on graphs and structures of **bounded tree-/clique-width**

References I



Alessandro Aloisio and Alfredo Navarra.

Constrained connectivity in bounded x -width multi-interface networks.

Algorithms, 13(2), 2020.



Bruno Courcelle, Joost Engelfriet, and Grzegorz Rozenberg.
Handle-rewriting hypergraph grammars.

Journal of Computer and System Sciences, 46(2):218 – 270, 1993.



Marek Cygan, Fedor V. Fomin, Lukasz Kowalik, Daniel Lokshtanov, Daniel Marx, Marcin Pilipczuk, Michal Pilipczuk, and Saket Saurabh.

Parameterized Algorithms.
Springer, 1st edition, 2015.

References II



Jörg Flum and Martin Grohe.
Parameterized Complexity Theory.
Springer, 2006.



Róbert Sásak.
Comparing 17 graph parameters.
Master's thesis, University of Bergen, Norway, 2010.